



**EXCLUSIVE  
TRADE DEALS  
AVAILABLE**

Ask in-branch  
for more details

# ROOFING SOLUTIONS

luma

skypod

equinox

equinox<sup>VEGA</sup>



# ROOFING, ROOFLINE & RAINWATER

## PRODUCT RANGE

ROOFLINE	4
LIGHTWEIGHT ROOFING	22
DRY VERGE	42
FLASHING	48
FLAT ROOFING	60
TIMBER	82
INSULATION	84
ROOFLIGHTS AND GLAZING	86
CONSERVATORIES	94
EQUINOX ROOF SYSTEM	96
LUMA FLAT ROOFLIGHT	104
SKYPOD LANTERN ROOF	106
ROOF GLAZING	112
CANOPIES AND PANELS	121
RAINWATER	122
UNDERGROUND DRAINAGE	142



RAINWATER

122



OVER 6000  
PRODUCTS  
IN-BRANCH



210+ BRANCHES  
NATIONWIDE



PRODUCT EXPERTS  
IN EVERY BRANCH



FREE SURVEYS  
& QUOTATIONS



CLICK & COLLECT  
IN-BRANCH



FREE ONSITE  
DELIVERY\*

\*Free onsite delivery on orders over the min. spend - Longer lead times apply to made-to-order items. Applies to mainland UK only and excludes Northern Ireland & Northern Scotland.





**EQUINOX**

**96**



**SKYPOD**

**106**



**ROOF TILES**

**24**



**FLASHING**

**48**



**ROOFLINE**

**4**



# ROOFLINE

## CONTENTS

Fascia boards	8
Capping boards	11
Finishing trims	14
Soffit boards	16
Ventilators and accessories	18
Fixings	19



## HIGH QUALITY FASCIAS, SOFFITS, CLADDING AND ACCESSORIES HELP TO ADD THE ESSENTIAL FINISHING TOUCHES TO ANY ROOFLINE PROJECT

- **Eaves protector**

A high quality, PVC eaves protector that ensures any roof underlay does not drape into the gutter. Eurocell eaves protector prevents water ponding behind fascia's and rotting of roof underlay in guttering thus reducing maintenance at eaves level - find out more on page 18.

- **3-in-1 felt support tray**

The 3-in-1 felt support tray incorporates an integral over fascia vent and bird comb to promote air circulation and limit animal and insects entering the roof.

- **Hollow soffit**

Our decorative hollow soffit board features in-built ventilation, helping to maintain airflow throughout your loft space - find out more on page 17.

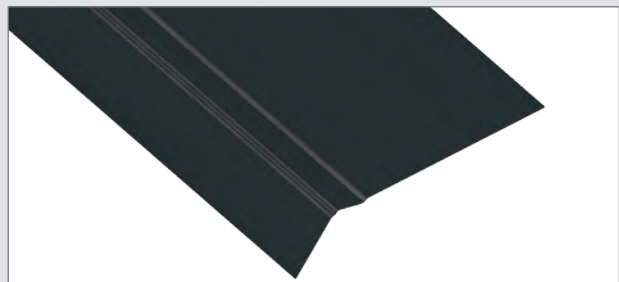

Eaves protector



3-in-1 ventilation

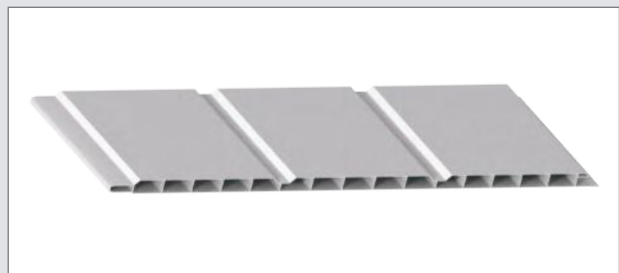

Hollow soffit

# ROOFLINE ANATOMY

## **A** FASCIA

For our range of direct replacement fascia and capping boards, [go to page 8](#)

## **B** DRY VERGE

Neaten up ragged roof edges with our universal dry verge range [on page 42](#)

## **C** TRIMS

From corner trims to joint trims, find all you need to complete your roofline job [on page 14](#)

## **D** SOFFITS

Choose from our range of plain and ventilated soffit boards [on page 16](#)

For more detailed information on our roofline range, including measurements and fitting instructions, please refer to our specification guide.

Call **08000 77 88 88** to request a copy, or download at [eurocell.co.uk](http://eurocell.co.uk)



# SIZE GUIDE

Our roofline products are available in various widths and thicknesses.

When we refer to **18mm** fascia board, we are talking about the thickness of the board.

The width of our fascia boards vary. In the example opposite, we show a **150mm** width board, but this particular product is available in widths up to 450mm – so you choose a size to best suit your project.





# INSTALLATION EXAMPLES

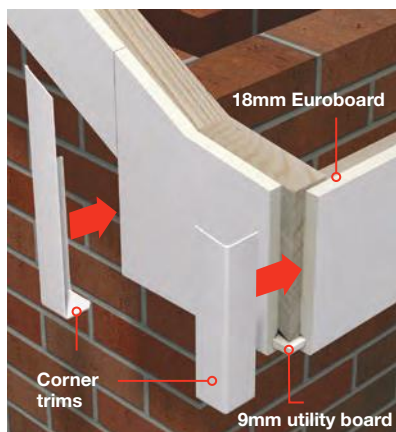

## FASCIA BOARD

18mm fascia board installed on a gable box end, finished with corner (**DCBCT**) and joint trims (**DCBJT**).



## SOFFIT BOARD

300mm vented hollow soffit board (**SB300**) allows air to flow freely in the roof space. This decorative board is complemented by sculpted 18mm ogee fascia boards (**OGE225**).



## CAPPING BOARD

9mm capping board (**CB250**) with 9mm utility board (**UB300**) fitted to a new 6mm plywood substrate\*.

\*Our capping boards can be fitted over existing fascia boards, providing that they are sound.

# FITTING TIPS

## FOILED AND LAMINATED BOARDS

All foiled and laminated boards should be fitted in lengths of **2.5m** maximum, to accommodate the expansion requirements – particularly on south facing elevations. Lift protective tape for inspection before installation.

## CAPPING BOARD

Capping board should only be affixed to existing timber fascias if they are sound. Where the integrity of existing fascia is compromised, replace with a timber backboard and use timber fillets for additional support.

## WHICH SEALANT?

Eurocell recommends Soudal neutral cure silicone sealants for all PVC-U roofline applications, for safe high-performance adhesion to PVC-U and masonry.

See pages **68-69**



# FASCIA BOARDS

## Double euroboard 18mm



Standard



Ogee

5m  
lengths

### Standard & Ogee double euroboard

#### Standard

Code	Size	Pack qty
DEB350	350mm x 5m	1 pack

#### Colour options:

64 / WO / RO / WLO1 / WZ / GY1 / GY1S\* / WY / WT1\* / WCR\* / GY3\* / GY2\* / GY4\*

DEB450	450mm x 5m	1 pack
--------	------------	--------

#### Colour options:

64 / CR / WO / RO / WLO1 / WZ / GY1 / GY1S\* / WY / WT1\* / WCR\* / GY3\* / GY2\* / GY4\*

#### Ogee

Code	Size	Pack qty
DOGE400	400mm x 5m	1 pack

#### Colour options:

64 White

## Box end board 18mm



Standard



Ogee

1.25m  
lengths

### 450mm Standard & 400/450mm Ogee

#### Standard

Code	Size	Pack qty
BEOGE400	400mm x 1.25m	1 pack
BEEB450	450mm x 1.25m	1 pack

#### Colour options:

64 White

# TRADE ESSENTIALS

## Euroboard 18mm



Standard



Ogee

5m  
lengths

### Standard euroboard

Code	Size	Pack qty
EB150	150mm x 5m	2 pack
EB175	175mm x 5m	2 pack

#### Colour options:

64 / CR / WO / RO / WLO1 / WZ / GY1 / GY1S\* / WY / WT1\* / WCR\* / GY3\* / GY2\* / GY4\*

EB200	200mm x 5m	2 pack
-------	------------	--------

#### Colour options:

64 / CR / WO / RO / WLO1 / WZ / GY1 / GY1S\* / WY / WT1\* / WCR\* / GY3\* / GY2\* / GY4\* / GY17\*

EB225	225mm x 5m	2 pack
-------	------------	--------

#### Colour options:

64 / CR / WO / RO / WLO1 / WZ / GY1 / GY1S\* / WY / WT1\* / WCR\* / GY3\* / GY2\* / GY4\*

EB250	250mm x 5m	2 pack
-------	------------	--------

#### Colour options:

64 / WO / RO / WLO1 / WZ / GY1 / GY1S\* / WY / WT1\* / WCR\* / GY3\* / GY2\* / GY4\*

EB300	300mm x 5m	2 pack
-------	------------	--------

#### Colour options:

64 White

### Ogee euroboard

Code	Size	Pack qty
OGE175	175mm x 5m	2 pack
OGE200	200mm x 5m	2 pack
OGE225	225mm x 5m	2 pack

#### Colour options:

64 White



# COLOUR OPTIONS



\* Made to order † Alternative codes if short codes don't work GY1 = GRW7016, GY1 = GRW7015, GY3 = GRW7155

# FASCIA BOARDS

## Bull-nosed fascia board 18mm

5m  
lengths



Replacement bull-nosed fascia is ideal for new build and refurbishment projects.

Code	Size	Pack qty
HBN150	150mm x 5m	2 pack
HBN175	175mm x 5m	2 pack
HBN200	200mm x 5m	2 pack
HBN225	225mm x 5m	2 pack
HBN250	250mm x 5m	2 pack

Colour options: 64 White

## Flat fascia board 16mm

5m  
lengths



This 16mm flat fascia board is a simpler alternative to standard fascia board, and is ideal for new build and refurbishment projects.

Code	Size	Pack qty
EFF150	150mm x 5m	2 pack
EFF175	175mm x 5m	2 pack
EFF200	200mm x 5m	2 pack
EFF225	225mm x 5m	2 pack
EFF250	250mm x 5m	2 pack
EFF300	300mm x 5m	2 pack
EFF400	400mm x 5m	1 pack (double ended)

### Colour options:

64 White, GY1 Anthracite Grey, WY Black Ash, WRO Rosewood



## HINTS & TIPS

Always use LMN silicone with roofline products.

Find out more  
on pages  
68-69



## Double bull-nosed fascia 18mm

18mm x 400mm board

Code	Size	Pack qty
HBN400	400mm x 5m	1 pack

Colour options: 64 White

## FINISHING OFF

We have a range of  
cleaning products.  
See in-branch





# CAPPING BOARDS

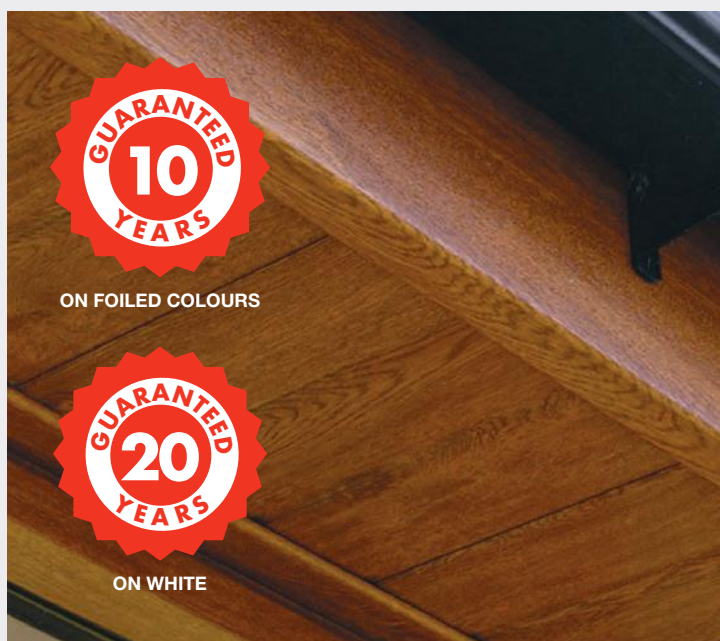

ATTRACTIVE CAPPING BOARDS TO REFRESH TIRED TIMBER

Stylish and cost-effective PVC-U boards designed to fit over existing timber fascias

Standard or decorative ogee fascia board for direct fixing to existing sound fascia boards or plywood

Designed for ease of fitting and low maintenance, with no painting required

An attractive and easy to install solution for any replacement roofline project

## Capping board 9mm - Standard



See page 9 or 13 for colour swatches

\* Made to order

† Alternative codes if short codes don't work

GY1 = GRW7016, GY1 = GRW7015, GY3 = GRW7155

### Standard capping board

Code	Size	Pack qty
<b>CB150</b>	150mm x 5m	4 pack
<b>Colour options:</b> 64 / WO / RO / WLO1 / WZ / GY1 / GY1S* / WY / BW / WT1* WCR* / GY3* / GY2* / GY4*		
<b>CB175</b>	175mm x 5m	4 pack
<b>Colour options:</b> 64 / CR / WO / RO / WLO1 / WZ / GY1 / GY1S* / WY / BW / WT1* WCR / GY3* / GY2* / GY4*		
<b>CB200</b>	200mm x 5m	4 pack
<b>Colour options:</b> 64 / WO / RO / WLO1 / WZ / GY1 / GY1S* / WY / BW / WT1* WCR / GY3* / GY2* / GY4*		
<b>CB225</b>	225mm x 5m	4 pack
<b>Colour options:</b> 64 / CR / WO / RO / WLO1 / WZ / GY1 / GY1S* / WY / BW / WT1* WCR / GY3* / GY2* / GY4*		
<b>CB250</b>	250mm x 5m	4 pack
<b>Colour options:</b> 64 / WO / RO / WLO1 / WZ / GY1 / GY1S* / WY / WT1* / WCR GY3* / GY2* / GY4*		
<b>CB300</b>	300mm x 5m	2 pack
<b>Colour options:</b> 64 / GY1 / WY*		

# CAPPING BOARDS

## Capping board 9mm - Ogee



5m  
lengths

### Ogee capping board

Code	Size	Pack qty
EOCB150	150mm x 5m	4 pack
Colour options: 64 / GY4*		
EOCB175	175mm x 5m	4 pack
EOCB200	200mm x 5m	4 pack
EOCB225	225mm x 5m	4 pack
Colour options: 64 / CR* / WO* / RO* / WLO1* / WZ* / GY1* / GY1S* / WY* / BW* / WT1* / WCR* / GY3* / GY2* / GY4*		
EOCB300	300mm x 5m	2 pack
Colour options: 64 / GY4*		

## Box end boards 9mm



1.25m  
lengths

### 450mm standard

Code	Size	Pack qty
BECB450	450mm x 1.25m	1 pack
Colour options: 64 White		

## Double capping board 9mm



Standard



Ogee

5m  
lengths

### Standard & Ogee double capping board

#### Standard

Code	Size	Pack qty
DCB350	350mm x 5m	2 pack
Colour options: 64 / WO / RO / WLO1 / WZ* / GY1 / GY1S* / WY / WT1 / WCR GY3* / GY2* / GY4*		
DCB450	450mm x 5m	2 pack
Colour options: 64 / WO / RO / WLO1 / WZ* / GY1 / GY1S* / WY / WT1* / WCR* GY3* / GY2* / GY4*		
Ogee		
Code	Size	Pack qty
EDOCB404	404mm x 5m	2 pack

Colour options: 64 White



See page 9 or 13 for  
colour swatches

\* Made to order

† Alternative codes if short codes don't work

GY1 = GRW7016, GY1 = GRW7015, GY3 = GRW7155

# COLOUR OPTIONS



\* Made to order † Alternative codes if short codes don't work GY1 = GRW7016, GY1 = GRW7015, GY3 = GRW7155







# FINISHING TRIMS



Add the right finishing touches to your roofline project with our range of finishing trims.

## FASCIA & CAPPING FINISHING TRIMS

<b>DCBJT</b>	Double capping board joint trim	<b>DCBCT</b>	Double capping board corner trim	<b>DCBICT90</b>	Double 90° internal corner trim	<b>CBECT135</b>	Universal external 135° corner trim
						<p><b>Colour options:</b> 64 / WY / GY1* / GY1S* / WO / WLO1 / RO</p>	
<p><b>Colour options:</b> 64 / CR / WY / WT1* / WCR* GY1 / GY1S* / GY3* / GY2* WO / WLO1 / RO / WZ / GY4* GY17*</p>		<p><b>Colour options:</b> 64 / CR / WY / WT1* / WCR* GY1 / GY1S* / GY3* / GY2* WO / WLO1 / RO / WZ / GY4* GY17*</p>		<p><b>Colour options:</b> 64 / CR / WY / WT1* / WCR* GY1 / GY1S* / GY3* / GY2* WO / WLO1 / RO / WZ / GY4* GY17*</p>		<p><b>CBICT135</b> Universal internal 135° corner trim</p> <p><b>Colour options:</b> 64 / WY / WO / WLO1* / RO</p>	
							

<b>EDOGJT</b>	Double Ogee joint trim
	
<b>Colour options:</b> 64 / WO* / RO*	

<b>EDOGCT</b>	Double Ogee corner trim
	
<b>Colour options:</b> 64 / WO* / RO*	

<b>EDOGICT90</b>	Double Ogee 90° internal corner trim
	
<b>Colour options:</b> 64 / WO* / RO*	

<b>HBNJT</b>	Double bull nosed joint trim
	
<b>Colour options:</b> 64 White	

<b>CBEC</b>	Capping board end caps
	
<b>Colour options:</b> WY / GY1 / WO / RO / WZ	

<b>HBNCT</b>	Double bull nosed corner trim
	
<b>Colour options:</b> 64 White	

<b>HBNICT</b>	Double bull nosed internal corner trim
	
<b>Colour options:</b> 64 White	

<b>RF1</b>	Roofline finial
	
<b>Colour options:</b> 64 / WY / WT1* / WCR* GY1 / GY1S* / GY3* / GY2* WO / WLO1 / RO / WZ / GY4* GY17	



See page 9 or 13 for colour swatches

\* Made to order

† Alternative codes if short codes don't work

GY1 = GRW7016, GY1 = GRW7015, GY3 = GRW7155

# SOFFIT BOARDS

A COMPLETE RANGE OF SOFFIT BOARDS FOR EVERY APPLICATION

Complete range of soffit boards are easy to fit and are fully compatible with our fascia systems for an exact colour match

Give your roofline an attractive, clean-edged finish, available in a range of colours

Available as standard utility board, vented Eurosoffit boards or lightweight hollow soffit boards



ON WHITE PRODUCTS

9mm utility board provides a simple, clean look and can be enhanced with separate vents and accessories to maintain airflow through your loft space

## Standard

Code	Size	Pack qty
<b>UB100</b>	100mm x 5m	4 pack
<b>Colour options:</b> 64 / WO / RO / WLO1 / WZ / GY1 / GY1S* / WT1* / WCR* / GY3* / GY2* / GY4*		
<b>UB125</b>	125mm x 5m	4 pack
<b>Colour options:</b> 64 White		
<b>UB150</b>	150mm x 5m	4 pack
<b>Colour options:</b> 64 / WO / RO / WLO1 / WZ / GY1 / GY1S* / WY / BW / WT1* / WCR / GY3* / GY2* / GY4* / GY17*		
<b>UB175</b>	175mm x 5m	4 pack
<b>Colour options:</b> 64 White		
<b>UB200</b>	200mm x 5m	4 pack
<b>Colour options:</b> WH / WO / RO / WLO1 / WZ / GY1 / GY1S* / WY / BW / WT1* / WCR / GY3* / GY2* / GY4* / GY17*		
<b>UB225</b>	225mm x 5m	4 pack
<b>Colour options:</b> 64 / WO		
<b>UB250</b>	250mm x 5m	2 pack
<b>Colour options:</b> 64 White		
<b>UB300</b>	300mm x 5m	2 pack
<b>Colour options:</b> WH / WO / RO / WLO1 / WZ / GY1 / GY1S* / WY / WT1* / WCR* / GY3* / GY2* / GY4* / GY17*		
<b>UB350</b>	350mm x 5m	2 pack
<b>Colour options:</b> 64 White		
<b>UB400</b>	400mm x 5m	2 pack
<b>Colour options:</b> 64 / WO / RO / WLO1* / WZ* / GY1 / GY1S* / WY* / WT1* / WCR* / GY3* / GY2* / GY4*		
<b>UB450</b>	450mm x 5m	2 pack
<b>Colour options:</b> 64 White		
<b>EUB605</b>	605mm x 5m	1 pack
<b>Colour options:</b> 64 White		

## Utility boards 9mm

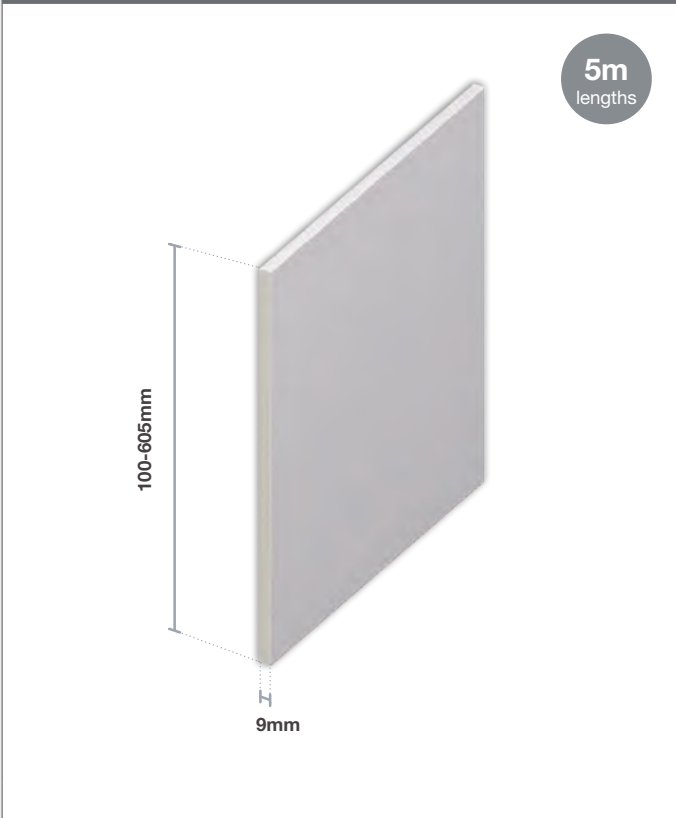

**i** See page 9 or 13 for colour swatches

\* Made to order

† Alternative codes if short codes don't work

GY1 = GRW7016, GY1 = GRW7015, GY3 = GRW7155





## Hollow soffit board 9mm

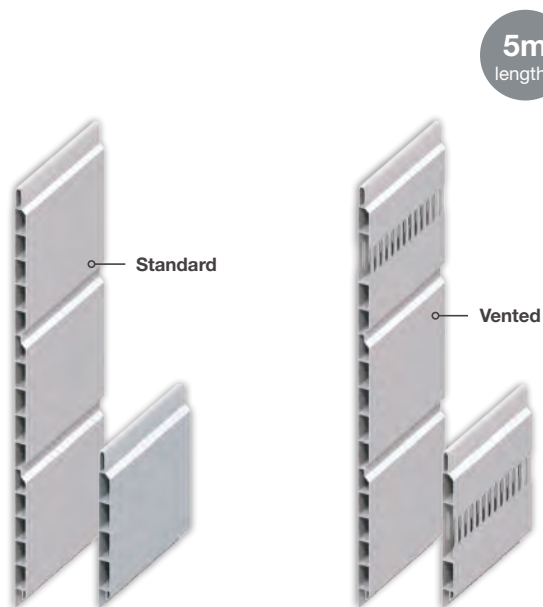

A decorative and lightweight alternative to traditional flat soffit boards

### Standard

Code	Size	Pack qty
SB100	100mm x 5m	10 pack

**Colour options:**  
64 / WO / RO / GY1 / GY1S

SB300	300mm x 5m	5 pack
-------	------------	--------

**Colour options:**  
64 / CR / WO / RO / WLO1 / WZ / GY1 / GY1S\* / WY / WT1\* / WCR\* / GY3\* / GY2\* / GY4\* / GY17\*

### Vented

Code	Size	Pack qty
VB100	100mm x 5m	10 pack
VB300	300mm x 5m	5 pack

**Colour options:**  
64 White

## 10 & 25mm airspace slots

### 10mm airspace

Code	Size	Pack qty
ES150	150mm x 5m	2 pack
<b>Colour options:</b> 64 / WO / RO / WY / WT1* / WCR* / GY1 / GY1S* / GY3* / GY2* / WZ* / WLO1* / GY4*		
ES200	200mm x 5m	2 pack
<b>Colour options:</b> W64 / WO / RO / WY / WT1* / WCR* / GY1* / GY1S* / GY3* / GY2* / WZ* / WLO1* / GY4*		
ES225	225mm x 5m	2 pack
ES250	250mm x 5m	2 pack
<b>Colour options:</b> 64 White		
ES300	300mm x 5m	2 pack
<b>Colour options:</b> 64 / WO / RO / WY / WT1* / WCR* / GY1* / GY1S* / GY3* / GY2* / WZ* / WLO1* / GY4*		
ES400	400mm x 5m	2 pack
EES450	450mm x 5m	1 pack
EES605	605mm x 5m	1 pack

### Colour options:

64 White

### 25mm airspace

Code	Size	Pack qty
DES150	150mm x 5m	2 pack
DES225	225mm x 5m	2 pack
DES300	300mm x 5m	2 pack
DES450	450mm x 5m	2 pack

### Colour options:

64 White

A COMPLETE RANGE OF EUROSOFFIT BOARDS FOR EVERY APPLICATION

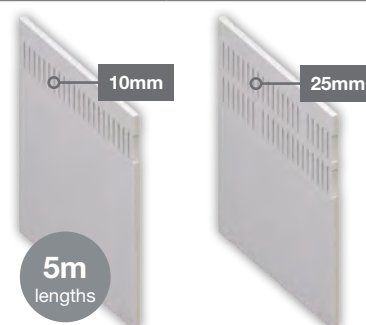

# VENTILATORS & ACCESSORIES



DISC VENTILATOR CSVE

Configure your roofline for optimum performance with our range of ventilators and accessories

**PT3064** 30mm panel trim  
30mm



5 x5m

**Colour options:**  
64 White

**PJ40** 40mm panel joint  
40mm



10 x5m

**Colour options:**  
64 White / ROF Rosewood / WY Black Ash / OF Golden Oak / CR Cream / WLO1 Irish Oak / GY1 Anthracite Grey / GY1S Anthracite Grey Smooth / WZ White Ash / WT1 Chartwell Green / GY2 Slate Grey / GY2S Slate Grey Smooth / GY4 Agate Grey / GY17 Balmoral

**BC25** 25mm board clip  
25mm



10 x5m

**Colour options:**  
64 White / CR Cream / WLO1 Irish Oak / GY1 Anthracite Grey / GY1S Anthracite Grey Smooth / WZ White Ash / ROF Rosewood / WYF Black / OF Golden Oak / WTI Chartwell Green / GY4 Agate Grey / GY17 Balmoral / GY2 Slate Grey / GY2S Slate Grey Smooth

**SV10** 10mm soffit ventilator  
10mm



10 x5m

**Colour options:**  
64 White / BK Black / O Oak / BN Brown

**CSVET** 70mm disc ventilator  
70mm



50 pack

**Colour options:**  
W White / BK Black / BR Brown / GY Grey / O Oak

**FET40** 40mm felt edge trim  
40mm



10 x5m

**Colour options:**  
64 White

**GEP** Eaves protector  
1.5mm

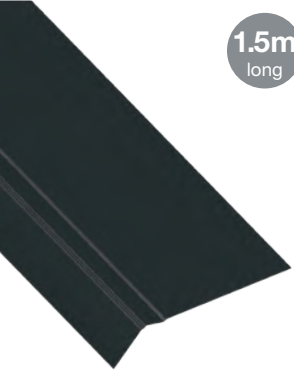

1.5m long

10mm over-fascia ventilator



1m long

Code	Size	Qty
OFV10	10mm	60
OFV25	25mm	50

**OFVS10** 10mm over-fascia vent with comb  
10mm



3-IN-1

1m long

**CF1000** Eaves comb filler  
1m



50 x1m

# FIXINGS

## Fixing pins



250 pack

### 30mm & 40mm fixing pins

Code	Size
FP30	30mm
FP40	40mm

#### Colour options:

WH White / BL Black / BR Brown / BE Beige / O Oak / RW Rosewood / GY Grey / WLO1 Irish Oak / CR Cream / T1 Chartwell Green\* / SGY3 Slate Grey\* / GYY Anthracite Grey / BG Balmoral\*  
(\* Made to order)

## Fixing nails



100 pack

### 50mm & 65mm fixing nails

Code	Size
FN50	50mm
FN65	65mm

#### Colour options:

WH White / BL Black / BR Brown / O Oak / RW Rosewood / GY Grey / WLO1 Irish Oak / CR Cream / T1 Chartwell Green\* / SGY3 Slate Grey\* / GYY Anthracite Grey / BG Balmoral\*  
(\* Made to order)

## Cladding pins



250 pack

### Cladding pins

Code	Size
CP 25	25mm
CP 30	30mm

#### Colour options:

WH White / BL Black / BR Brown / O Oak / RW Rosewood / GY Grey / WLO1 Irish Oak / CR Cream / T1 Chartwell Green\* / SGY3 Slate Grey\* / GYY Anthracite Grey / BG Balmoral\*  
(\* Made to order)

# ADHESIVES & ACTIVATORS

## SG50THICK

Superglue 50gm



- Easy to apply
- High viscosity

## ACT200

Activator 200ml



- Instant cure and bonding in seconds

## SGKIT

Superglue & activator kit 50gm/200ml



- Instant cure and bonding in seconds



# easy-trim<sup>®</sup>

Roofing & Construction Products

WE THINK OUR PRODUCT IS GREAT.

**BUT DON'T JUST TAKE OUR WORD FOR IT.**

Real reviews of Easy-Trim Ridge Kits from installers\*



**I WOULD BUY AGAIN**

Used on a new garage. Easy to install and well manufactured.



**MORTAR FREE FIXING**

Excellent product, mortar free mechanical ridge tile fixing with easy to follow instructions.



**10/10**

Perfect. Easy to install and everything needed supplied. Plastic pieces (terracotta in mine) matched well to the ridges.



**BEST RIDGE KIT AROUND**

Always use this dry ridge kit for clay angled ridge, fits the best



**RECOMMEND**

Quick and easy to use. Good Result.



**QUICK AND EASY DRY RIDGE SYSTEM 5\***

Easy to fit. All parts required are included also instructions dedicated to the dry ridge system, looks and feels like a quality product, with plenty of ventilation via the roll webbing.



ASK FOR THE EASY-TRIM BRAND IN YOUR LOCAL **eurocell** BRANCH

\* Reviews taken from a selection of merchants selling online





# easy-trim<sup>®</sup>

Roofing & Construction Products

**DRY FIX • VENTILATION • MEMBRANES  
LEAD ALTERNATIVES • OVER FASCIA VENTS**

**ASK FOR THE EASY-TRIM BRAND IN YOUR LOCAL  BRANCH**





# LIGHTWEIGHT ROOFING



## CONTENTS

Envirotile	24
Tapco	30
Slateskin	34
Metrotile	36
Corrugated Roof - Onduline	40
Dry verge	42
Dry valley	46



## EUROCELL'S COMPREHENSIVE RANGE OF LIGHT WEIGHT ROOF TILES ARE LIGHT WEIGHT AND EASY TO INSTALL. WITH 3 LEADING OPTIONS WITH ENVIROTILE, TAPCO AND METROTILE, WE'VE GOT IT COVERED.

Adding to the growing range of lightweight roofing products, and New to the range Eurocell has added Onduline corrugated roofing sheets.

- **Envirotile** is a revolutionary roof tile system developed by a roofer for roofers, and has a unique fixing system which is fully compliant with BS 5534. It's leading design means it requires just 12 tiles per m<sup>2</sup>, and can be installed to a minimum of 12.5° pitch. A flat, precision manufactured, recycled polymer, lightweight roof tile with excellent green credentials.
- **Tapco** slate is a stylish range of traditional format roof tiles made from 100% virgin resins and limestone. A stylish addition to conservatory or other light weight roofing jobs, Tapco is extremely hard wearing, easy to fit and can be installed to a minimum of 14° pitch.
- **Metrotile** the lightweight steel roofing systems, pressed from the highest quality steel and providing a durable solution to all of your roofing needs. From small conservatories to large-scale new build projects.
- **Slateskin** The leading GRP sheet roof tile system from our Equinox conservatory roof system, which gives a traditional slate-effect in half the time is now available as a stand-alone product suitable for a range of domestic applications.
- **Onduline** The original bituminous roof sheet for renovating the roofs of a versatile mix of applications from garden sheds, pergolas, summer houses and workshops.

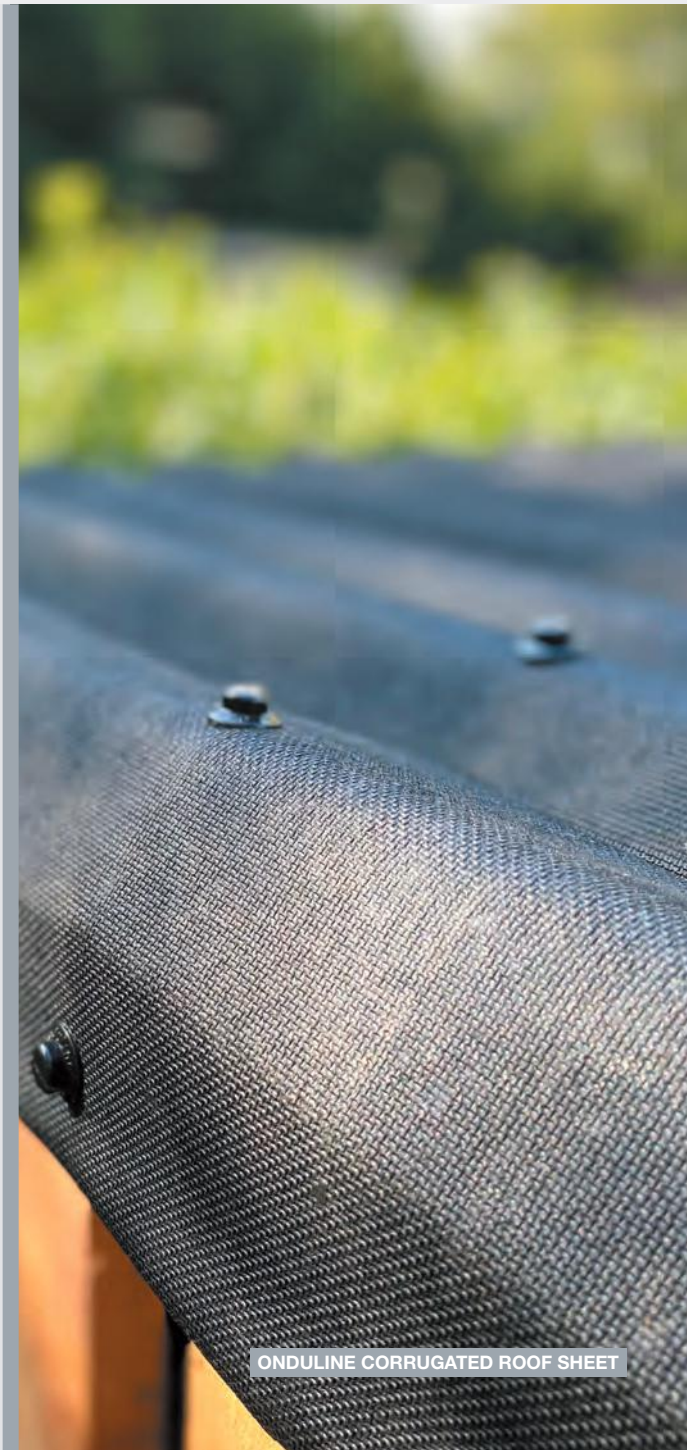

ONDULINE CORRUGATED ROOF SHEET



**SAVE TIME,  
SAVE MONEY**

with  
**envirotile®**

**COST SAVING, SUSTAINABLE ROOF TILE**

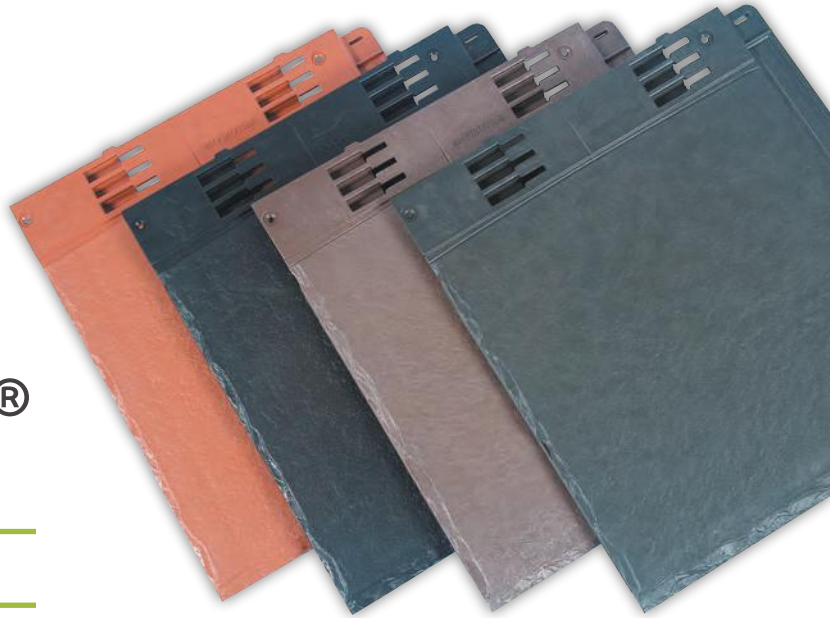

**UNIQUE DESIGN**  
fully storm tested

ON AVERAGE  
**20%<sup>\*</sup>**  
CHEAPER  
PER ROOF

## FEATURES & BENEFITS



Faster to fit and more secure with unique fitting system



Lightweight and easy to install



Made from 75% recycled materials



Anti fungal properties



Can be installed to a minimum 12.5° pitch



Weather tested to 147mph



40-year guarantee for peace of mind

\* Compared to other lightweight roof tiles



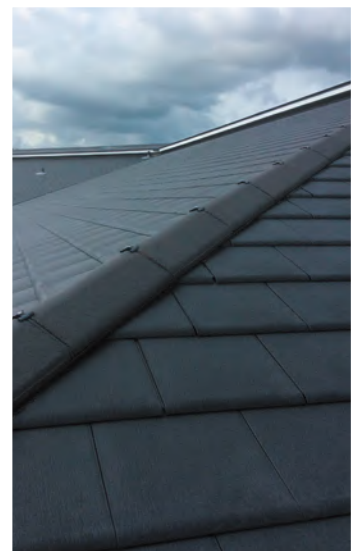

**AVAILABLE IN 2 FINISHES,  
4 COLOURS & 3 SIZES**

**SLATE-EFFECT FINISH**



**STANDARD FINISH**



**TERRACOTTA**



**SLATE GREY**



**DARK BROWN**

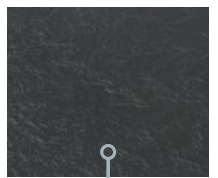

**ANTHRACITE GREY**

**FULL RANGE OF COMPONENTS IN A RANGE OF COLOURS AND FINISHES**



**RIDGE CAP**



**GABLE END CAP**



**HIP CAP**



**HIP END CAP**



**RIDGE TO APEX**



# COMPOSITE ROOF TILES - ENVIROTILE

## ENVIROTILE SLATE

### Why choose Envirotile?

The lightest, biggest roof tiles on the market with a unique interlocking system that makes any job quick and easy to fix.

Unbreakable, dry cut tiles made from 75% recycled materials save hassle and environmental impact.

Performing on pitches as low as 12.5 degrees and good for all structures that can't handle a lot of weight, Envirotile is perfect whatever the job.

So whether the problem roof is a main frame or a lightweight conservatory, Envirotile is the answer.

Envirotile slate	
Code	Size
ENVLSL	Single – Size: L:365mm x W:325mm x D:11mm
ENVSLD	Double – Size: L:365mm x W:630mm x D:11mm
ENVSLH	Half – Size: L:365mm x W:175mm x D:11mm



Ridge cap	
Code	Size
ENVSLRC	L:425mm x W:245mm x H:105mm
<b>Colour options:</b> SG Slate Grey / BR Brown / TR Terracotta / BK Anthracite Grey	



Hip cap	
Code	Size
ENVSLHC	L:425mm x W:165mm x H:70mm
<b>Colour options:</b> SG Slate Grey / BR Brown / TR Terracotta / BK Anthracite Grey	



Hip end cap	
Code	Size
ENVSLHEC	L:180mm x W:245mm x H:90mm
<b>Colour options:</b> SG Slate Grey / BR Brown / TR Terracotta / BK Anthracite Grey	



Ridge to apex	
Code	Size
ENVSLRAC	L:252mm x W:292mm x H:145mm
<b>Colour options:</b> SG Slate Grey / BR Brown / TR Terracotta / BK Anthracite Grey	



Gable end cap	
Code	Size
ENVSLGEP	L:28mm x W:325mm x H:178mm
<b>Colour options:</b> SG Slate Grey / BR Brown / TR Terracotta / BK Anthracite Grey	



## ENVIROTILE STANDARD

Envirotile standard	
Code	Size
ENVSTS	Single – L:365mm x W:325mmxD:11mm
ENVSTD	Double – L:365mmx W:630mmxD:11mm
Colour options: AG Anthracite Black / GY Grey / BR Brown / TR Terracotta	



Ridge cap	
Code	Size
ENVSTRC	L:475mm x W:300mm x H:170mm
Colour options: AG Anthracite Black / GY Grey / BR Brown / TR Terracotta	



Hip cap	
Code	Size
ENVSTHC	L:425mm x W:150mm x H:70mm
Colour options: AG Anthracite Black / GY Grey / BR Brown / TR Terracotta	



ENVSTHEC	Hip end cap L:180mm x W:150mm x H:70mm
	
Colour options: AG Anthracite Black / GY Grey / BR Brown / TR Terracotta	

ENVSTRTA	Ridge to apex L:280mm x W:300mm x H:170mm
	
Colour options: AG Anthracite Black / GY Grey / BR Brown / TR Terracotta	

ENVSTGEC	Gable end cap L:30mm x W:300mm x H:170mm
	
Colour options: AG Anthracite Black / GY Grey / BR Brown / TR Terracotta	

### COLOUR OPTIONS - SLATE

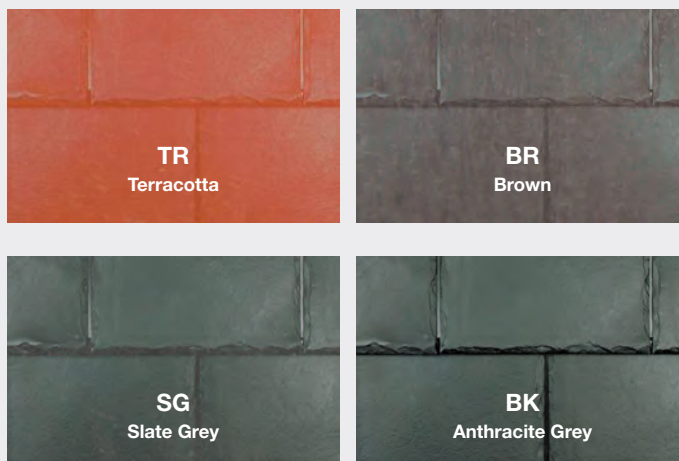

### COLOUR OPTIONS - STANDARD

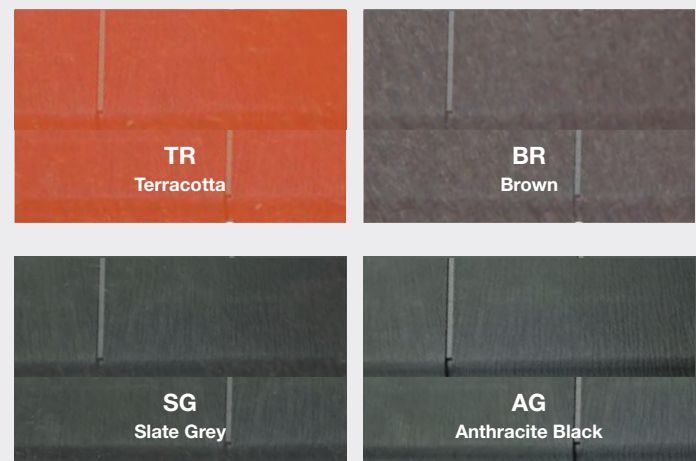

# COMPOSITE ROOF TILES - ENVIROTILE

## ENVIROTILE STANDARD/SLATE

**Standard lowline vent**



Code	Size
<b>ENVSTLVT</b>	L:365mm x W:325mm x D:11mm + Profile
<b>Colour options:</b> AG Anthracite Grey / GY Grey / BR Brown / TR Terracotta	

**Standard cowl vent**



Code	Size
<b>ENVSTCVT</b>	L:365mm x W:325mm x D:11mm + Profile
<b>Colour options:</b> AG Anthracite Grey / GY Grey / BR Brown / TR Terracotta	

**Ventilated eaves bar/starter rail**



Code	Size
<b>ENVEB</b>	L:600mm x W:48mm x H:12mm

**ENV3MDV** **3m dry verge**  
L:3000mm



**Colour options:**  
AG Anthracite Grey / BR Brown / TR Terracotta

**ENVDVB** **Dry verge bracket**



**Colour options:**  
AG Anthracite Grey / BR Brown / TR Terracotta

**ENVIROTILE**

Save money and time with this revolutionary, lightweight, interlocking roof tile system

**Screw cover cap**



Code	Pack qty	Size
<b>ENVSCCL</b>	25	Large
<b>ENVSCCS</b>	25	Small
<b>Colour options:</b> AG Anthracite Black / GY Grey / BR Brown		

**PERFECT PARTNER**



See page 51 for more details

**ENVABTSOA** Mechanical dry fix - abutment wall soaker  
L:3000mm

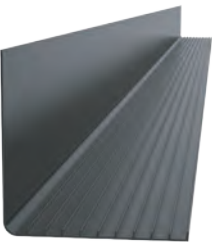

**ENNVALLEY** Valley with water drainage channels  
L:3000mm



**ENVMALEINS** Male to male ridge insert for double hip roofs



Colour options:  
SG Slate Grey / BR Brown / TR Terracotta / BK Anthracite Black

**ENVSRPA110** Square to round pipe adaptor  
110mm



**ENVMXCL** Flexitube and clips  
112mm



**PERFECT PARTNER**



See page 88 for more details

**Envirolay**

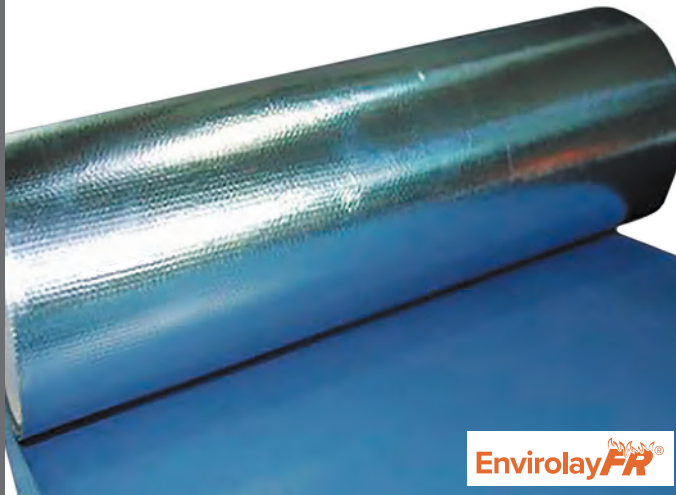

**EnvirolayFR®**

Code	Size
<b>ENVIROLAY</b>	D x 130mm x L:25000mm

EnvirolayFR® must be used on all domestic dwellings, (standard roofing membrane can be used on a conservatory roof).

**ENVTAPE** Duo plus tape  
D x 40mm x L:50M



**Fixings - SS pozi pan self tapping screw**

Code	Size	Qty
<b>ENVSCREW90</b>	90 x 6.3mm	50 pack
<b>ENVSCREW32</b>	32 x 4.2mm	50 pack



# COMPOSITE ROOF TILES - TAPCO



## **TAPCO SLATE** *Classic*

**SLATE...  
BUT NOT AS YOU  
KNOW IT!**

TapcoSlate Classic Coachman Mix Pictured



Whether you have a conservatory, modern house or a listed building, TapcoSlate Classic adds splendour, elegance and tradition to your home.

It is authentically shaped with textured surfaces and riven edges moulded from authentic slates that makes TapcoSlate Classic almost indistinguishable from natural slate – yet it has an even more refined appearance. TapcoSlate Classic will not crack, break or delaminate, and its product formulation and manufacturing processes provide durability, performance, and longevity for many years to come.

TapcoSlate Classic is tested above and beyond UK and European standards and has the certification and results from the best testing houses in UK and European construction, for your peace of mind:



intertek bre warringtonfire

By providing a lightweight and easily-installed product, installation costs are lower, with less site waste!

### FEATURES & BENEFITS



Incredible 40-Year Warranty!



Lightweight: as low as 12kg/M<sup>2</sup>



Easily Cut & Shaped



Highly Impact Resistant



Low 14° Pitch



Simple to Install



### Tapco slate roof tiles



Code	Pack qty	Size
SLATE	25	445 x 292mm

**Colour Options:**  
BR Brick Red / BS Stone Black / CC Charcoal / CN Chestnut / GY Pewter Grey / OG Olive Green / PM Plum / RR Red Rock / COACH790 Coachman Mix

### Tapco slate ridge/hip caps



Code	Pack qty	Size
RIDGE	1	440 x 160mm

**Colour options:**  
790 Coachman Mix / BR Brick Red / BS Stone Black / CC Charcoal / CN Chestnut / OG Olive Green / PM Plum / PW Pewter / PWC Pewter Grey / RR Red Rock

### End cap



Code	Pack qty
RIDGEEND**25-29DEG	1
RIDGEEND**30-34DEG	
RIDGEEND**35-40DEG	

**Colour options:**  
(\*PG) Pewter Grey / (\*SB) Black / (\*CB) Chestnut Brown / (\*PL) Plum (\*RR) Red Rock / (\*BR) Brick Red

### Angle ridge to hip junction



Code	Pack qty
RIDGEHIP**14-17DEG	1
RIDGEHIP**18-23DEG	
RIDGEHIP**24-30DEG	

**Colour options:**  
(\*PG) Pewter Grey / (\*SB) Black / (\*CB) Chestnut Brown / (\*PL) Plum (\*RR) Red Rock / (\*BR) Brick Red

# COMPOSITE ROOF TILES - TAPCO



**Soaker cowl vent 10k airflow  
(15 to 90 degrees)**

Code	Pack qty
G3801COVENTBLK	1
G3804COVENTPWT	1
G3712COVENTCHE	1
G3809VENTRR	1
G3706VENTPL	1
G3709VENTBR	1

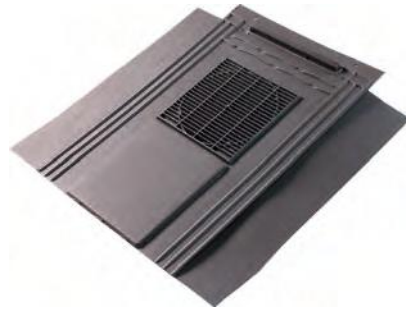

**Inline vent 10k airflow  
(20 to 90 degrees)**

Code	Pack qty
GV11712INVENTCHE	1
GV11801INVENTBLK	1
GV11804INVENTPWT	1
INVENTGV11406PL	1
INVENTGV11809RR	1
INVENTGV709BR	1



**Abutment ventilator  
(1m length - min. pitch 15 degrees)**

Code	Pack qty
OB56TABV	1



**Slate verge**

Code	Pack qty
VERGEBS	1



**RidgeMaster plus 11" ridge  
ventilation system**

Code	Pack qty
71100002	10



**HipMaster 11" hip ventilation  
system**

Code	Pack qty
71111002	10



### Rafter roll ventilator 450mm x 6m

Code	Pack qty
TRRV6M	1



### Inline vent pipe adaptor

Code	Pack qty
GV110000PIPE	1



### Soaker cowl vent pipe adaptor

Code	Pack qty
GV110	1



### Dry verge jointing clips

Code	Pack qty
CO2PJBL	1

### SEAC Multipurpose Screws

Code	Size	Pack qty
MP5030	5.0 x 30mm	200
MP5050	5.0 x 50mm	200
MP5080	5.0 x 80mm	200

## GET A TRADE ACCOUNT TODAY

ASK IN BRANCH FOR MORE DETAILS



**OVER 6000  
PRODUCTS AVAILABLE  
IN-BRANCH**



**210+ BRANCHES  
NATIONWIDE**

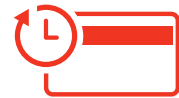

**INSTANT TRADE CREDIT  
AVAILABLE**



**DEDICATED  
ACCOUNT MANAGER**



**EXCLUSIVE TRADE  
ACCOUNT PRICING**



**ONLINE TRADE  
ACCOUNT**



# GRP SHEET ROOF TILES



**slateskin®**

The leading **GRP sheet roof tile system** from our Equinox conservatory roof system, which gives a traditional slate-effect in half the time is now available as a stand-alone product suitable for a range of domestic applications.

**AUTHENTIC SLATE LOOKS**

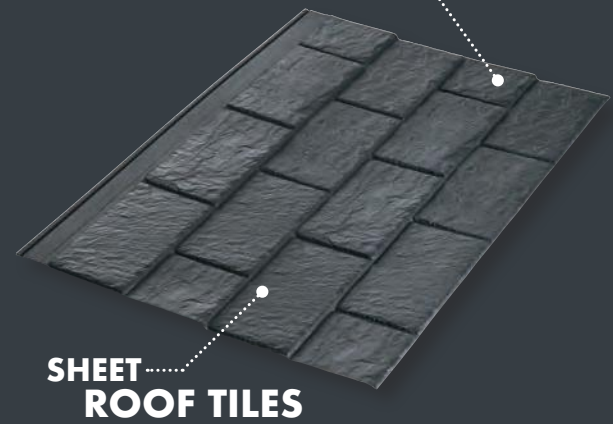

## Tile sheet

Code	Pack qty
ERS 1340GY2-2M	2m
ERS 1340GY2-4M	4m
ERS 1340GY2-6M	6m



## Ridge gable end cap

Code
ERS 1338GY2-FG



## Victorian hip end cap

Code
ERS 1329GY2-FG



## Edwardian hip end cap

Code
ERS 1325GY2-FG



## Ridge/hip length cap (6m)

Code
ERS 1321GY2-FG



## Victorian 5-way ridge top cap

Code
ERS 1326GY2
<b>Also available in:</b> 15° (ERS 1334GY2) / 20° (ERS 1335GY2) 30° (ERS 1336GY2) / 35° (ERS 1337GY2)

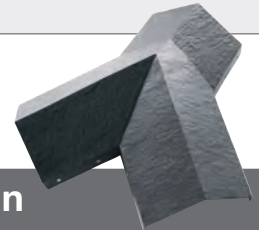

## Edwardian 3-way ridge top cap

Code	Size
ERS 1322GY2	25°
<b>Also available in:</b> 15° (ERS 1330GY2) / 20° (ERS 1331GY2) 30° (ERS 1332GY2) / 35° (ERS 1333GY2)	

# slateskin®

## A GREAT LOOKING SLATE-EFFECT ROOF IN 50% LESS TIME

### WHY CHOOSE SLATESKIN?

Slateskin - a sheet tiling system that allows you to fit a realistic slate-effect, water-resistant system to Equinox roofs in around 50% less time compared to authentic conservatory tiling methods.



Up to 50% faster to install than traditional tiling methods



Saves you time and money!

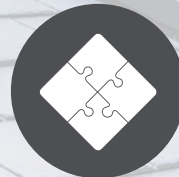

Easy-fit sheet system



Only tile system tested to achieve 5° pitch



Tough and hard-wearing



Precision-engineered for enhanced performance



25-year guarantee for peace of mind

# equinox®

# envirotile®

the perfect combination.

## envirotile®

Envirotile now works perfectly with our Equinox solid tile warm roof solution making it not just quicker but easier to fit.



Less tiles required per sqm for a quicker install



Lightweight & easy to install



Interlocking fitting system

## equinox®



Easy and quick installation in 2 days\*  
\* Water tight on day one



U-values as low as 0.15



LABC/LABSS certified



GET A SOLID ROOF QUOTE IN UNDER AN HOUR



AND DELIVERED TO YOU IN JUST 7 DAYS



# STEEL ROOF TILES - METROTILE



## THE LIGHTWEIGHT STEEL ROOF TILE

- Can be installed to a minimum 15° pitch
- Unique 'hidden fix' system - no nails exposed
- Lightweight, light and easy to handle and install
- Durable, colour stability and protects against UV light
- Stable, resistance to extreme weather
- Strong, exceptional strength and resistant to damage
- Fire proof, Conforms with the European standards

## metrotile LIGHTWEIGHT ROOFING

Metrotile is the leading supplier of lightweight roofing systems, pressed from the highest quality steel and providing a durable solution to all of your roofing needs. From small conservatories to large-scale new build projects, Metrotile has you covered.

- Lightweight roofing is easy to manoeuvre
- Improved insulation to the residential or commercial premises
- Rigorously tested to withstand harsh weather conditions and vandalism
- Highest possible external fire resistance rating
- 40 Year weatherproof guarantee
- Stunning aesthetics
- Expert technical support on hand

## STEEL ROOF TILES COLOURS AVAILABILITY

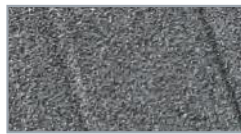

CHARCOAL

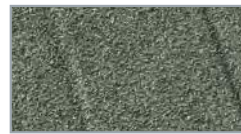

MOSS GREEN



ANTIQUE RED



EBONY



BURNT UMBER



**SPECIAL ORDER  
DELIVERED IN 5 DAYS**

## Metrotile shingle



Code	Size	Description
ERS1301	1335x300mm	METROTILE SHINGLE

**Colour options:**  
CA Charcoal / AR Antique Red / BU Burnt Umber / MG Moss Green / EB Ebony



**COLOUR CODES:**

AR / Antique Red

BU / Burnt Umber

CA / Charcoal

EB / Ebony

MG / Moss Green

**Metrotile  
angle ridge  
veranda**



Code	Colour	Pack qty
ARV	AR/BU/CA/EB	1

**Metrotile  
end cap  
hip 135**



Code	Colour	Pack qty
ECH135	AR/BU/CA/EB	1

**Metrotile  
end cap hip  
veranda**



Code	Colour	Pack qty
ECHARV	AR/BU/CA/EB	1

**Metrotile end  
cap ridge  
veranda**



Code	Colour	Pack qty
ECR	AR/BU/CA/EB	1

**Metrotile  
delta ridge**



Code	Colour	Pack qty
ERS1302	AR/BU/CA/EB/MG	1

**Metrotile  
5-way  
junction**



Code	Colour	Pack qty
ERS1304	AR/BU/CA/EB/MG	1

**Metrotile  
2pc non-  
handed barge**

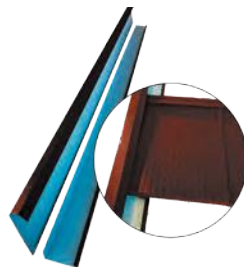

Code	Colour	Pack qty
ERS1307	AR/BU/CA/EB/MG	1

**Metrotile  
touch up  
kit**



Code	Colour	Pack qty
ERS1308	AR/BU/CA/EB/MG	1

# STEEL ROOF TILES - METROTILE

## COLOUR CODES:

AR / Antique Red    BU / Burnt Umber    CA / Charcoal    EB / Ebony    MG / Moss Green



**Metrotile ridge end cap**

Code	Colour	Pack qty
ERS1305	AR/BU/CA/EB/MG	1



**Metrotile 90 deg hip end cap**

Code	Colour	Pack qty
ERS1306	AR/BU/CA/EB/MG	1



**Metrotile 135 hip end cap**

Code	Colour	Pack qty
ERS1310	AR/BU/CA/EB/MG	1



**Metrotile 5 way adaptor veranda**

Code	Colour	Pack qty
Y5ARV	Antique Red	1
Y5BUV	Burnt Umber	1
Y5CV	Charcoal	1
Y5EV	Ebony	1



**Metrotile y-junction veranda 25 deg**

Code	Colour	Pack qty
YAR25V	Antique Red	1
YBUV25	Burnt Umber	1
YCV25V	Charcoal	1
YE25V	Ebony	1



**Metrotile y-junction**

Code	Colour	Pack qty
ERS1303	AR/BU/CA/EB/MG	1



**Metrotile woodshake**

Code	Colour	Pack qty
ERS1311	Antique Red/ Bronze/Charcoal	1



**Hip / Ridge Vent Strip (600mm)**

Code	Qty
METROHIPVENT	1

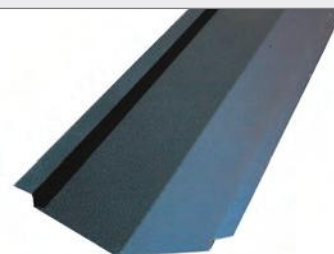

**Metrotile valley lining 2.2m x 200mm**

Code	Pack qty
ERS1309	1



# metrotile

LIGHTWEIGHT ROOFING



THE NEW HOME FOR



## The World's Leading Producer of Lightweight Steel Roofing Systems



A **metrotile** roof weighs just one-seventh of so called 'traditional' roof materials such as slate or clay, yet offers superior benefits. The low weight ensures a rapid installation and a significant reduction in strain on the supporting structure and foundations. The use of the highest quality steel ensures unmatched security, while the stone and acrylic glaze coating gives your rooftop a stunning finish - all backed by a **forty year weatherproof guarantee**.

[www.metrotile.co.uk](http://www.metrotile.co.uk)



**metrotile shingle**



Burnt Umber



Charcoal

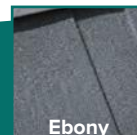

Ebony

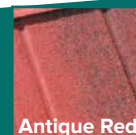

Antique Red

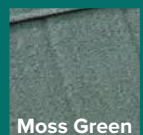

Moss Green



ISO9001  
ISO14001



NBS Source  
PARTNER



# CORRUGATED ROOF SHEET - ONDULINE



MARKET LEADING LIGHTWEIGHT ECO-FRIENDLY ROOFING SHEETS

The original bituminous roof sheet for renovating the roofs of a versatile mix of applications from garden sheds, pergolas, summer houses and workshops.

Lightweight

Eco-Friendly

Available in a choice of colours

Easy to install

**SPECIAL ORDER  
DELIVERED IN 7 DAYS**



Conditions apply.

Extremely tough bituminous corrugated roof sheets. Made from 50%-60% recycled materials and suitable for renovations and new build DIY, agricultural and commercial roofing projects.

- BBA certified
- Guaranteed waterproofing: 15 years
- Virtually maintenance free
- Eco-friendly: Very low carbon footprint
- Fast and easy to install: no specialist tooling required
- Proven to withstand strong winds
- Noise reducing material

**Onduline**<sup>®</sup>  
Lightweight roofing systems

## CORRUGATED ROOF SHEET COLOURS AVAILABILITY



BLACK



RED

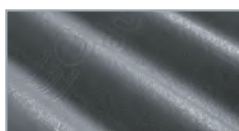

GREY



GREEN



BROWN

**Onduline classic and  
clear sheeting**  
2000 x 950 x 3mm

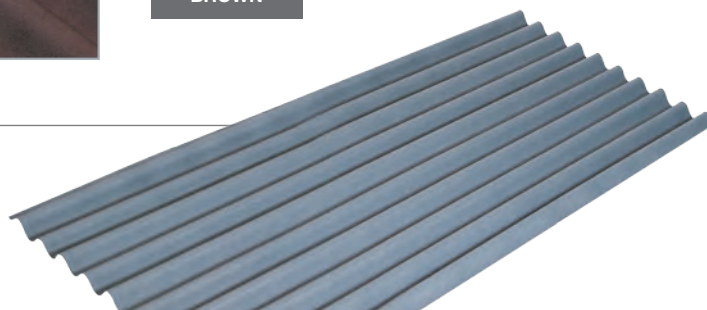

Code	Size	Corrugations	Colours available	Corrugation height	Weight per m <sup>2</sup>	Weight per sheet
<b>ONDLINE</b>	L:2000mm x W:950mm x D:3mm	10	BK Black / GN Green / GY Grey / RD Red / BR Brown	38mm	3.4kg/m <sup>2</sup>	6.4kg/m <sup>2</sup>
<b>BITCLEAR</b>	L:2000mm x W:950mm x D:1.2mm	10	Translucent/Transparent	38mm	1.89kg/m <sup>2</sup>	3.6kg/m <sup>2</sup>

## Gable Slim Verge Angles



Code	Pack qty	Size
ONDSLVRG	1	1000 x 130mm

**Colour options:**  
BK Black / GN Green / GY Grey

## Ridge capping



Code	Pack qty	Size
ONDRDG	1	1000 x 420mm

**Colour options:**  
BK Black / GN Green / BR Brown / GY Grey

## Fixing nails



100  
pack

400  
pack

Code	Size
BN100	18mm head x 65mm

**Colour options:**  
BK Black / GN Green / GY Grey / RD Red / BR Brown

BN400	18mm head x 65mm
-------	------------------

**Colour options:**  
BK Black / GN Green / RD Red / BR Brown

## Fixing screws



100  
pack

Code	Size
USS100	65mm length

**Colour options:**  
BK Black / GN Green / GY Grey





# DRY VERGE

Our Verge U is truly universal in that the units can be used on the left and right side of the verge, and they are fully compatible with most tile types. The unique design combines fast, simple installation with exceptional holding qualities. A tight secure fit is easily achieved ensuring roof tiles are held firmly in place and not vulnerable to wind dislodgement.

- Neatens roof edges
- An attractive weather and pest-proof finishing touch to any roof
- Can be retro-fitted to existing buildings to tidy roof edges
- The simple, secure clip fixing system makes it easy to install and avoids the problem of wind uplift
- Meets the mechanical fixing requirements of BS 5534
- None-handed units – can be used on both the left and right verge
- Unique design to create a completely sealed verge preventing water ingress and insect/bat infestation
- Manufactured from Polypropylene for excellent flexibility and UV stability.





# DRY VERGE

## Easyverge half round ridge cap C/W flapcap



Code	Colours
HRRIDGECAPBLK	Black
HRRIDGECAPBRN	Brown
HRRIDGECAPGRY	Grey
HRRIDGECAPTER	Terracotta

## Easyverge angled ridge cap C/W flapcap



Code	Colours
ARIDGECAPBLK	Black
ARIDGECAPBRN	Brown
ARIDGECAPGRY	Grey
ARIDGECAPTER	Terracotta

## Easyverge U universal verge system



Code	Colours
UNIVERGEBLK	Black
UNIVERGEBRN	Brown
UNIVERGEGRY	Grey
UNIVERGETER	Terracotta



## Easyverge starter & end cap

Code	Colours	Qty
VERGEPACKBLK	Black	2 Pack
VERGEPACKBRN	Brown	2 Pack
VERGEPACKGRY	Grey	2 Pack
VERGEPACKTER	Terracotta	2 Pack

## Continuous dry verge end cap



Code	Colours
CDVENDBLK	Black
CDVENDBRN	Brown
CDVENDWHT	White

## Slate dry verge continuous



5m lengths

Code	Colours
SLATEDVCONTBLK	Black

## R type continuous dry verge



5m lengths

Code	Colours
RTYPECONTBLK5M	Black
RTYPECONTBRN5M	Brown
RTYPECONTWHT5M	White

## Continuous dry verge connector



Code	Colours
CDVCONBLK	Black
CDVCONBRN	Brown
CDVCONWHT	White

# DRY RIDGE

## DRY RIDGE

### EasyRidge F Dryfix Ridge Kit 6m



Code

EASYRIDGEF6BLK

### Easyridge F plus dryfix ridge kit 6m



Code

EASYRIDGEFBLK

EASYRIDGEFGRY

Colour

Black

Grey

## THE COST EFFECTIVE SOLUTION FOR YOUR EAVES LEVEL VENTILATION REQUIREMENTS

Our 3-in-1 eaves ventilation kit includes everything you need to provide 6 metres of eaves ventilation

### Easyridge F hip accessory kit 6m



Code

EASYRIDGE/HIPKIT

## 3-in-1 Eaves Vent Kit



New

Code

ETEVI/3IN1VENTPAK



# easy-trim<sup>®</sup>

Roofing & Construction Products

**A GREAT PRODUCT IS GOOD QUALITY AND EASY TO USE.**

# THINK WE'VE NAILED IT!

Real reviews of Easy-Trim Verge  
Units from installers\*

★★★★★

**TERRIFIC**

Terrific product, so easy  
to install

★★★★★

**GREAT PRODUCT**

Very good product. Easy to slot  
together but still a firm hold.  
Plastic is rigid but not brittle like  
some I have used.

★★★★★

**EASY FIT. NICE  
QUALITY AS ALWAYS.**

As a professional I like this  
brand. Easy to fit and clip  
together. Lots of installation  
videos on YouTube 🍌

★★★★★

**QUICK AND EASY**

Easy to fit, roof line  
looks great. A1.



★★★★★

**HAPPY CUSTOMER**

Good quality product.  
Easy to use. Sturdy.

★★★★★

**REALLY EASY TO FIT**

EasyVerge is well named as it's  
really easy to fit and looks good.

★★★★★

**EASY TO INSTALL**

Easy to install, great  
finish to roof.

**ASK FOR THE EASY-TRIM BRAND IN YOUR LOCAL  BRANCH**

\* Reviews taken from a selection of online independent merchants



# DRY VALLEY & BONDING STRIP

THE COST-EFFECTIVE ALTERNATIVE TO LEAD GUTTERS. V-FLOW VALLEY TROUGHS CAN BE USED WITH CLAY OR CONCRETE TILES OR SLATE ROOFS, AS WELL AS PROFILED GRP OR METAL ROOFS. OPTIONS ARE AVAILABLE FOR WET OR DRY FIXING (WITH OR WITHOUT MORTAR).

Life expectancy of over 30 years

Virtually maintenance-free

Convincing simulation of traditional lead

Manufacture assured to BS EN ISO 9001

Light and easy to transport, handle and install

BBA Certification (No 18/5546)



**SPECIAL ORDER  
DELIVERED IN 7 DAYS**



## GRP VALLEY TROUGHS

### Standard valley trough

(Double lap) slate/tiles



Code	Size	Pack qty
GSVT1	W:330mm x L:3m	10

### Narrow valley trough

(Single lap tile) over batten fix



Code	Size	Pack qty
GTB13	W:360mm x L:3m	10

### Standard valley trough

(Single lap tile) over batten



Code	Size	Pack qty
GTB14	W:400mm x L:3m	10

### Standard valley trough

(Slate or tile) under batten



Code	Size	Pack qty
GTF14	W:400mm x L:3m	10

**GJS1** **Secret joint strip**  
(Bonded in channel)  
W:216mm x L:3m

10 pack qty



**GAS1** **Abutment soaker**  
W:140mm x L:3m

10 pack qty



**GDFBS110** **Dry fix bonding strip**  
(Concrete/Clay tile)  
W:225mm x L:3m

10 pack qty



**GDFBS70** **Dry fix bonding strip - use with natural/slate man made**  
W:225mm x L:3m

10 pack qty



**GDFCD110** **90° top closure - use with GDFVT110**

10 pack qty



**GFVTC110** **Eaves closure piece - for GDFVT110**

10 pack qty



**GDFVT110** **Dry fix valley trough - (Concrete/Clay tile)**  
W:400mm x L:3m

10 pack qty



**GDFVT70** **Dry fix valley trough - (Natural/Man made slate)**  
W:400mm x L:3m

10 pack qty



**GDFVTC70** **90° top closure use with GDFVT70**

10 pack qty



## PRO DRY VALLEY & PRO BONDING STRIPS

**Pro valley bonding strip**



Code	Size	Pack qty
<b>GDFBSUB10</b>	D:100mm x W:225mm x L:3m	10
<b>GDFBSUB70</b>	D:70mm x W:225mm x L:3m	10

**Pro valley**



Code	Size	Pack qty
<b>GDFVTUB10</b>	D:105mm x W:400mm x L:3m	10
<b>GDFVTUB55</b>	D:55mm x W:400mm x L:3m	10
<b>GDFVTUB80</b>	D:80mm x W:400mm x L:3m	10



# FLASHING

## CONTENTS

Midland Lead	50
Lead alternative	54
Bostik Flashband	55
Easy-trim Lead R	56
Cromar Leadax	58



## FLASHING IS AN IMPERVIOUS MATERIAL INSTALLED TO WEATHERPROOF AREAS OF A STRUCTURE.

For roofing applications, lead is traditionally used, but we also offer lead free alternatives, which are suitable for rainwater harvesting.

- **Midland Lead** - Eurocell offer an extended range of Lead Flashing from Midland Lead, with Code 3 – Code 8 available either in branch or to order. Lead can be used on various applications including Flat roofs, dormer, chimney flashing, cover flashing, lead valleys and soakers.
- **Bostik Flashband** Self Adhesive Flashing Tape for Roofs is a flexible bitumen strip that bonds instantly to most building materials to provide a permanent, watertight seal.
- **Easy Trim Lead-R** - BBA approved Easy Lead R and Easy Lead R Smooth are aluminium based, high performance, low cost flashing products. They are used as a replacement for traditional lead in flat and pitched roof applications.
- **Cromar Leadax** - Leadax is the first lead alternative in the World with the same properties as Traditional Lead. Leadax is not harmful to health or the environment. A second-generation lead alternative which is not only easier to use but also easier on your pocket.



Midland Lead



Bostik Flashband



Easy Trim Lead-R



Cromar Leadax

# LEAD FLASHING & ROOFING LEAD



**Lead remains the material of choice for roofing, weatherproofing, radiation protection and soundproofing.**

- Malleable but durable and typically lasts over 100 years
- Sustainable and environmental friendly
- 100% recyclable
- Cost effective, practical and stylish
- Easy to use
- Adaptable and fit-for-purpose
- Available in codes and sizes to suit you

## What Lead code you need for your next project

If you want to know what lead code to use and where, use our handy guide...

LEAD DETAILING	CODE 3 1.32mm	CODE 4 1.80mm	CODE 5 2.24mm	CODE 6 2.65mm	CODE 7 3.15mm	CODE 8 3.55mm
Flat roof	x	x	•	•	•	•
Dormer	x	x	•	•	•	x
Chimney flashing	x	•	•	•	x	x
Lead valley	x	•	•	•	•	x
Cover flashing	x	•	•	•	x	x
Soakers	•	•	x	x	x	x

**CODE 3** Thickness (mm): 1.32      Weight (kg/m<sup>2</sup>): 15.0

**Uses:** Lead soakers

**CODE 4** Thickness (mm): 1.80      Weight (kg/m<sup>2</sup>): 20.4

**Uses:** Soakers, flashings, vertical cladding, hip and ridge flashing, chimney flashing, apron and cover flashings, pitched valley gutters, bay tops and canopies, vertical cladding

**CODE 5** Thickness (mm): 2.24      Weight (kg/m<sup>2</sup>): 25.4

**Uses:** Flat roofing, pitched roofs, flashing, vertical cladding, hip and ridge flashing, dormers, parapet, box and tapered valley gutters, bay tops and canopies, chimney flashing, apron and cover flashings, pitched valley gutters, vertical cladding

**CODE 6** Thickness (mm): 2.65      Weight (kg/m<sup>2</sup>): 30.1

**Uses:** Flat roofing, pitched roofs, hip and ridge flashing, dormers, parapet, box and tapered valley gutters, chimney flashing, apron and cover flashings, pitched valley gutters, bay tops and canopies, vertical cladding

**CODE 7** Thickness (mm): 3.15      Weight (kg/m<sup>2</sup>): 35.7

**Uses:** Flat roofing, pitched roofs, dormers, parapet, box and tapered valley gutters, pitched valley gutters, bay tops and canopies, vertical cladding

**CODE 8** Thickness (mm): 3.55      Weight (kg/m<sup>2</sup>): 40.3

**Uses:** Flat roofing, pitched roofs, parapet, box and tapered valley gutters, bay tops and canopies.



Eurocell stock various Code 3 Lead roll sizes, with an extended range Code 4-8 available to order

## Real Lead Sheet

- BBA, NHBC & EPD Approved
- Made from 100% recycled, circular raw materials
- UK Manufactured
- Full range of thicknesses for all applications of leadwork

ASK IN BRANCH FOR THE LATEST LEAD PRICE



### MACHINE CAST LEAD

Code 3 (1.32mm) to Code 8 (3.55mm)

Standard lengths 3m & 6m

Standard widths 150mm - 1400mm

Supported by a range of ancillary products

Eurocell stock various Code 3 Lead roll sizes, with an extended range Code 4-8 available to order



## Patination Oil



Code	Size
PO1	500ml

Code 3	Code 4	Size
ML3150/3	ML4150/3	150mm x 3m
ML3180/3	ML4180/3	180mm x 3m
ML3210/3	ML4210/3	210mm x 3m
ML3240/3	ML4240/3	240mm x 3m
ML3240/6	ML4240/6	240mm x 6m
ML3300/3	ML4300/3	300mm x 3m
ML3330/3	ML4330/3	330mm x 3m
ML3360/3	ML4360/3	360mm x 3m
ML3390/3	ML4390/3	390mm x 3m
ML3420/3	ML4420/3	420mm x 3m
ML3450/3	ML4450/3	450mm x 3m
ML3150/6	ML4150/6	150mm x 6m
ML3180/6	ML4180/6	180mm x 6m
ML3210/6	ML4210/6	210mm x 6m
ML3240/4	ML4240/4	240mm x 4m
ML3270/3	ML4270/3	270mm x 3m
ML3300/6	ML4300/6	300mm x 6m
ML3330/6	ML4330/6	330mm x 6m

Pack qty 1

Code 3	Code 4	Size
ML3360/6	ML4360/6	360mm x 6m
ML3390/6	ML4390/6	390mm x 6m
ML3420/6	ML4420/6	420mm x 6m
ML3450/6	ML4450/6	450mm x 6m
ML3480/3	ML4480/3	480mm x 3m
ML3510/3	ML4510/3	510mm x 3m
ML3540/3	ML4540/3	540mm x 3m
ML3570/3	ML4570/3	570mm x 3m
ML3600/3	ML4600/3	600mm x 3m
ML3750/3	ML4750/3	750mm x 3m
ML3800/3	ML4800/3	800mm x 3m
ML3900/6	ML4900/6	900mm x 6m
ML31000/6	ML41000/6	1000mm x 6m
ML31350/3	ML41350/3	1350mm x 3m
ML31400/3	ML41400/3	1400mm x 3m
ML3480/6	ML4480/6	480mm x 6m
ML3510/6	ML4510/6	510mm x 6m
ML3540/6	ML4540/6	540mm x 6m
ML3570/6	ML4570/6	570mm x 6m
ML3600/6	ML4600/6	600mm x 6m
ML3750/6	ML4750/6	750mm x 6m
ML3900/3	ML4900/3	900mm x 3m
ML31000/3	ML41000/3	1000mm x 3m
ML31200/3	ML41200/3	1200mm x 3m
ML31350/6	ML41350/6	1350mm x 6m
ML31400/6	ML41400/6	1400mm x 6m



# MARKET EXPERTS IN LEAD PRODUCTION AND SUPPLY



Midland Lead Ltd, Kiln Way, Woodville,  
Swadlincote Derbyshire DE11 8ED

t: +44 (0)1283 224 555  
e: [sales@midlandlead.co.uk](mailto:sales@midlandlead.co.uk)

PROUD TO BE A SUPPLY PARTNER OF



## FULL RANGE OF THICKNESSES FOR ALL APPLICATIONS OF LEADWORK

### PATINATION OIL

Patination oil prevents the unsightly white carbonate staining of lead, tiles and brickwork that can occur when lead work is left untreated. Available in 125ml, 500ml & 1 litre bottles.



### FIXING CLIPS

Fixing clips are a fast and efficient way to fix lead sheet into a joint. Available in packs of 20 & 50 clips.



### MULTISLATES

A lead and rubber universal weathering slate - code 4 lead base - can be dressed to any tile shape and will accept pipes from 25 mm to 150 mm in diameter. Our multislates can be used on both flat & pitched roofs.

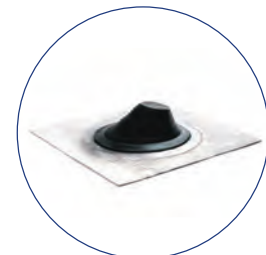

# LEAD ALTERNATIVE FLASHING

## WHAT YOU NEED TO KNOW

- Roof flashings could be used to replace traditional lead
- Easily cut with sharp scissors or a knife
- At least half the installation time of traditional lead
- No re-sale value that not prone to theft
- Self-adhesive lead flashings available
- Easy to install, easy to handle, and easy on the wallet



## GET A TRADE ACCOUNT TODAY

ASK IN BRANCH FOR MORE DETAILS



**OVER 6000  
PRODUCTS AVAILABLE  
IN-BRANCH**



**210+ BRANCHES  
NATIONWIDE**



**INSTANT TRADE CREDIT  
AVAILABLE**



**DEDICATED  
ACCOUNT MANAGER**



**EXCLUSIVE TRADE  
ACCOUNT PRICING**



**ONLINE TRADE  
ACCOUNT**





**BOSTIK FLASHBAND SELF-ADHESIVE FLASHING TAPE**

Bostik Flashband Self Adhesive Flashing Tape for Roofs is a flexible bitumen strip that bonds instantly to most building materials to provide a permanent, watertight seal.

Instant watertight seal

Quick and easy application

For new build or emergency repairs



## LEAD ALTERNATIVE – FLASHBAND

Flashband is easily applied using just hand pressure and a seam roller and is ideal for new build, maintenance and repair projects, including:

### Roofing

- Replace damaged lead flashing
- Seal upstands and eve pieces
- Roof capping
- Edge flashing on roofing felt
- Repair roofing felt or joints on flat roofs

### Drainage

- Seal or repair valley gutters, guttering and down pipes

Flashband has four layers of protection, meaning it's both tear and impact resistant and can withstand extreme temperatures of up to 100°C.

### Four Layers of Protection

- Lacquer coating
- Heavy duty aluminium foil
- Tear resistant polyester membrane
- Polymer enhanced bitumen adhesive

### Bostik Flashband



Code	Size	Colour
BTKFB10X100	100mm x 10m	Grey
BTKFB10X150	150mm x 10m	Grey
BTKFB10X225	225mm x 10m	Grey

# LEAD-FREE FLASHING

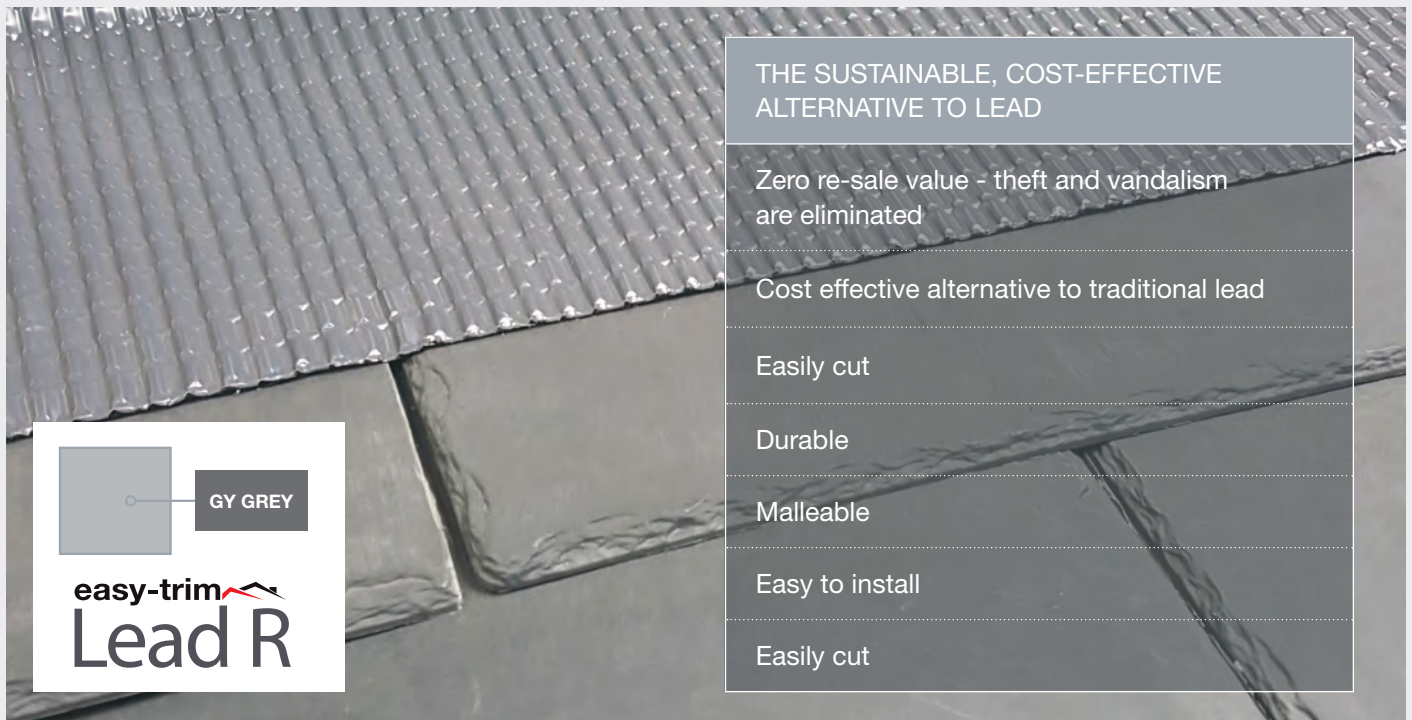

THE SUSTAINABLE, COST-EFFECTIVE ALTERNATIVE TO LEAD

Zero re-sale value - theft and vandalism are eliminated

Cost effective alternative to traditional lead

Easily cut

Durable

Malleable

Easy to install

Easily cut

## LEAD ALTERNATIVE - EASY LEAD R

BBA approved Easy Lead R and Easy Lead R Smooth are aluminium based, high performance, low cost flashing products. They are used as a replacement for traditional lead in flat and pitched roof applications.

Made of sheet aluminium with a protective anti-corrosion coating and a high-performance butyl adhesive on the underside. Installation is simple, with no special tools required it can be cut with a knife or scissors.

Easy Lead R has a unique corrugated pattern, so it is easy to form and to adapt to various surfaces; this malleability ensures the permanent water tightness of the product and an attractive appearance every time.

Easy Lead R Smooth has the same benefits and characteristics of Easy Lead R, only with a smooth finish thus effectively mimicking the appearance of traditional lead. Easy Lead R provides a permanent bond to brickwork, roof tiles and most popular construction materials.





## Lead-free flashing rolls

Code	Size	Description
LEAD-R150SG	150mm x 5m	EasyLead R Smooth
LEAD-R300SG	300mm x 5m	EasyLead R Smooth
LEAD-R450SG	450mm x 5m	EasyLead R Smooth
LEAD-R600SG	600mm x 5m	EasyLead R Smooth
LEAD-R150CG	150mm x 5m	EasyLead R Textured
LEAD-R300CG	300mm x 5m	EasyLead R Textured
LEAD-R450CG	450mm x 5m	EasyLead R Textured
LEAD-R600CG	600mm x 5m	EasyLead R Textured

### SMOOTH FINISH

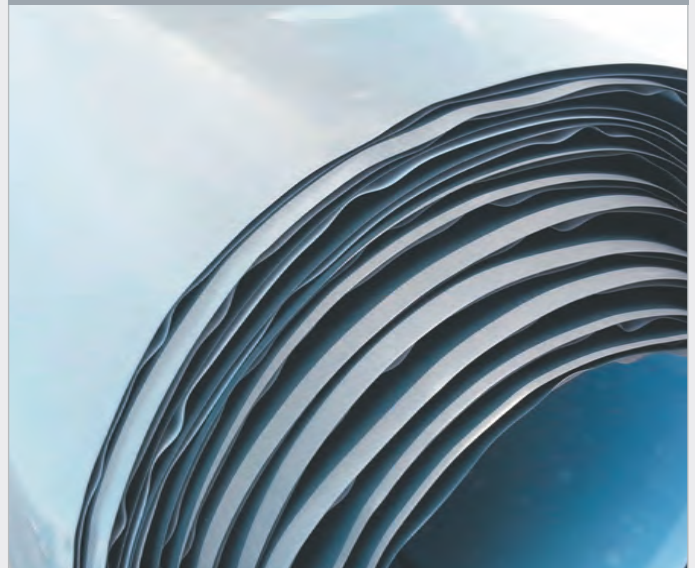

### TEXTURED FINISH

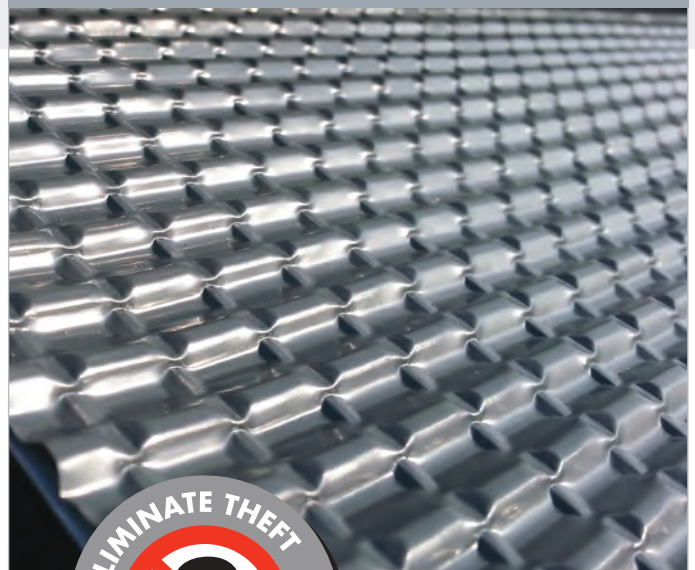

#### Typical application

- Abutments
- Chimneys
- Dormers
- Saddles
- Soakers
- Stepped
- Valleys
- Windows and rooflights
- Valleys and gutters





# LEAD-FREE FLASHING

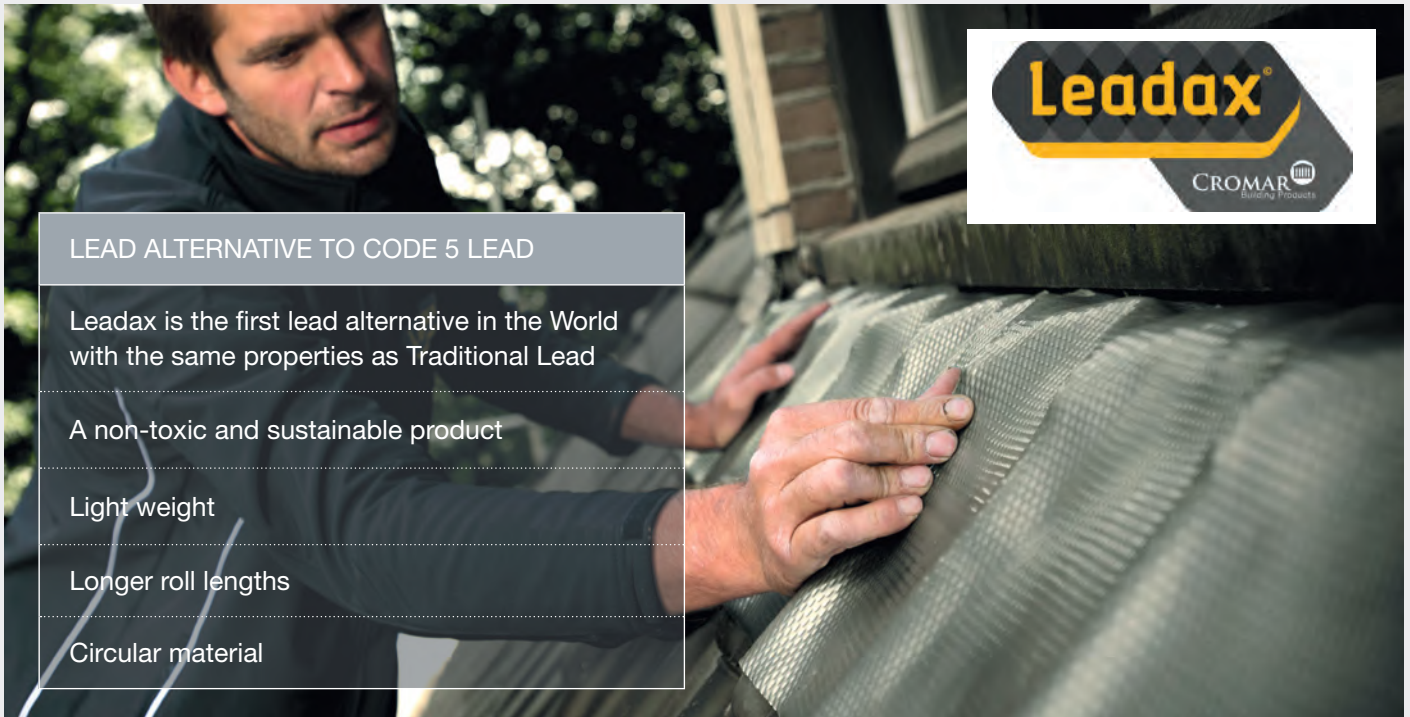

## LEAD ALTERNATIVE TO CODE 5 LEAD

Leadax is the first lead alternative in the World with the same properties as Traditional Lead

A non-toxic and sustainable product

Light weight

Longer roll lengths

Circular material

## LEAD ALTERNATIVE - LEADAX

Leadax is the first lead alternative in the World with the same properties as Traditional Lead. Leadax is not harmful to health or the environment. A second-generation lead alternative which is not only easier to use but also easier on your pocket.

### Features and benefits:

**Cheaper** - Leadax is cheaper to buy than traditional lead, and because Leadax is also faster to install, this leads to lower installation costs.

**A non-toxic and sustainable product** - Unlike traditional water-resistant materials, Leadax does not contain any heavy metals.

**Circular material** - The basic raw material is recycled PVB. PVB is the foil that is used in laminated glass (e.g. car windows or safety glass).

**Light weight** - Leadax is lighter than lead and therefore easier to use.

**Longer roll lengths** - Leadax is available in longer strips. So you can seal larger areas with less overlap, saving you materials and time.

**Finish** - Leadax comes in lead grey as standard. However, the product is also available in black, roof tile red and different colours are available, such as copper at an extended lead-time.

**Durable** - Leadax has the same natural look as traditional sheet lead, however it leaves no staining on roof tiles or masonry. The life expectancy is at least 20 years.

**Certified** - Leadax has been certified by BBA & KIWA.



# LEAD ALTERNATIVE - LEADAX

**Leadax**  
6m roll

Code	Size	Pack qty	Colour
KLD/150/GY	150mm x 6m	1	Lead Grey
KLD/200/GY	200mm x 6m	1	Lead Grey
KLD/250/GY	250mm x 6m	1	Lead Grey
KLD/300/GY	300mm x 6m	1	Lead Grey



Code	Size	Pack qty	Colour
KLD/400/GY	400mm x 6m	1	Lead Grey
KLD/450/GY	450mm x 6m	1	Lead Grey
KLD/600/GY	600mm x 6m	1	Lead Grey
KLD/1000/GY	1000mm x 6m	1	Lead Grey

**KLAD/ROLLER**    Leadax roller

**KLAD/SCISSORS**    Leadax scissors

**KLD/CLIP**    Lead fixing clip  
50 par bag

50 pack qty

**M/LEADAX**    Leadax fixing sealant

**KLAD/PENNYROLLER**    Leadax penny roller

## FEATURES & BENEFITS



Malleable, durable, waterproof and lightweight



Zero resale value, eliminating theft and vandalism



20 years+ life expectancy



Requires no additional sealants or tape



High performance adhesive for a permanent bond



Resistant against corrosion and UV degradation



Smooth or textured finish



No special tools required - simply cut with a knife or scissors



# FLAT ROOFING

## CONTENTS

Firestone rubber roofing	62
Liquid waterproofing Ultra Flex	70
Cromar ProGRP	72
Flexiglass GRP	74
TriRoof HPX	76
Acrypol repair	77
GRP Trims	78
Roofing membrane	79
Timber	82
Insulation	84

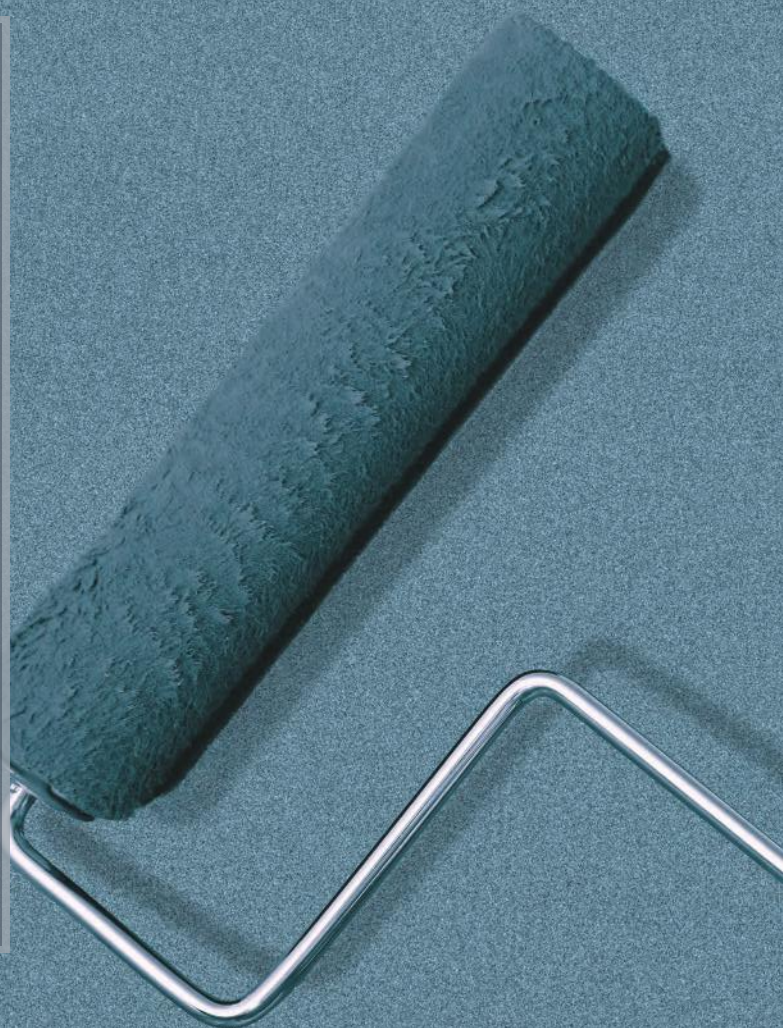



- **Firestone Rubber Cover™ EPDM**  
Flat roofing membranes for residential use.
- **Ultra Flex Liquid Flat Roof Waterproofing** is a single component liquid that cures through moisture contact and therefore is used directly from the container with no requirement for additional additives.
- **Cromar PRO GRP** is the professional choice for glass fibre flat roofing. Cold-applied and with high impact and fire resistance, it provides a seamless, highly durable, flexible and virtually maintenance-free finish for almost any flat roof surface. Pro GRP is available in component form.
- **HPX TriRoof HPX** is the ultimate Roofing Overlay System, designed to work all year round from the colder, wetter months and throughout the heat of the summer. TriRoof HPX can be applied effortlessly on nearly any surface and even on wet or damp substrates, meaning you don't have to plan your work around the weather.
- **Acrypol +** is The original instant waterproof solution for emergency leaks & failing flat roofs.

## PERFECT PARTNER



### Tongue & Groove OSB3



SKYPOD ROOF LANTERN WITH CROMAR PRO GRP GLASS FIBRE FLAT ROOFING SYSTEM

# FLAT ROOFING - RUBBER



FIRESTONE RUBBERCOVER™ EPDM  
FLAT ROOFING MEMBRANE FOR  
RESIDENTIAL USE.

Watertight & durable roofing solution

Excellent resistance to ageing (UV and ozone)

Excellent flexibility at low temperatures (-45°C)

Large dimension membranes significantly  
decrease installation time

Compatible with green roofing systems and  
photovoltaics

Repaired/extended easily during service-life

Successfully installed worldwide – from the arctic conditions of Siberia to the blistering heat of the Middle East, Firestone EPDM membranes ensure the water-tightness of tens of thousands of buildings.

## Key Features & Benefits

- Watertight & durable roofing solution
- Excellent resistance to ageing (UV and ozone)
- High elasticity (>300% elongation)
- Excellent flexibility at low temperatures (-45°C)
- High puncture resistance
- Membrane and seams display high resistance to hydrostatic pressure
- Fire resistance to external sources (Low-Slope-Fire-Retardant EPDM)
- Inert (no solvents or plasticizers). The membrane composition remains constant over time
- Compatible with the collection of rainwater
- Resistant to micro-organisms
- Large dimension membranes significantly decrease installation time
- Reduced environmental impact compared to other waterproof membranes and in line with ecological requirements
- Compatible with green roofing systems and photovoltaics
- Easy installation and can be repaired/extended easily during service-life







## Firestone rubber membrane

Code	Description	Size
RCR3MSQM	Rubbercover EPDM Roll 3.05x30.5m	3.05 x 30.5m
RCR45MSQM	Rubbercover EPDM ROLL 4.57 X 30.5m	4.57 x 30.5m
RCR6MSQM	Rubbercover EPDM Roll 6.1x30.5m	6.1 x 30.5m



## Firestone contact spray

For bonding rubber to substrate

Code	Size
RCSPRAY	750ml



## Water Based Adhesive

Code	Size
RCWBA10F	10l
RCWBA5F	5l
RCWBA25F	2.5l



## Contact Bonding Adhesive - in green

Code	Size
RCCBA5F	5l
RCCBA10F	10l
RCCBA25F	2.5l



## Quickprime Plus

For bonding rubber to rubber

Code	Size
RCQP1	1l



## Firestone EasySealant

Code	Size
RCES290	290ml

## Eurocell Contact Adhesive

Code	Size
RCBA10	10l
RCBA2.5	2.5l
RCBA5	5l

# FLAT ROOFING - RUBBER

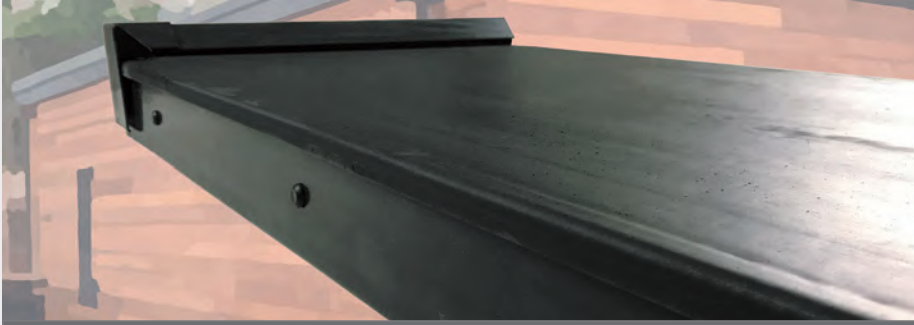

## Trims & flashing

Code	Description	Size
RCULTRACURB	Ultratrim Curb Edge Profile 65mm x 3.5m	65mm x 3.5m
RCULTRAGUTT	Ultratrim Gutter Edge 65mm x 2.5m	65mm x 2.5m
RCULTRACOR	Ultratrim Corner Endcap (Large)	N/A
RCULTRAEND	Ultratrim Trim Endcap (Small)	N/A
RCULTRACLIP	Ultratrim Joint Clips	N/A
RCWALL	Wall Flashing 70mm x 3m	70mm x 3m

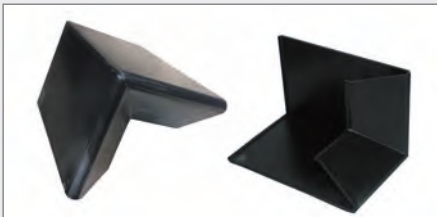

## Ultratrim external corner

Code	Description
RCULTRAEXT	Ultratrim External Corner

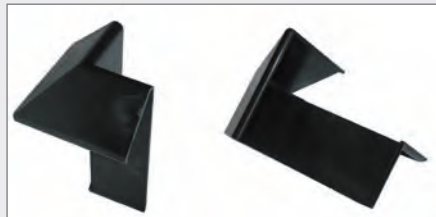

## Ultratrim internal corner

Code	Description
RCULTRAINT	Ultratrim Internal Corner



## Batten cover strip

Code	Size
RCQSBCSRM	152mm x 30.5m



## Formflash roll

Code	Size
RCFFLASROLL	229mm x 15.25m



## Quickscrubbers

Code	Description
RCQSH	Quickscrubber Handles
RCQTSP	Quickscrubber Pads



## Moulded pipe flashings

Code	Description
RCQSPB	Moulded Pipe Flashings



## Batten cover strip

Code	Size
RCQSBCSRM	152mm x 30.5m



## Formflash roll

Code	Size
RCFFLASROLL	229mm x 15.25m



## Quickseam corner flashing

Code	Description
RCQSCF	Corner Flashing



**get ahead with...**



**+ flat roof edge trims from...**



**Authorised RubberCover™ Training Program...**

- Formally recognised certificate
- Authorised installer recognition
- Enhanced support
- Extended warranties



Standard warranty = 10 years

Extended warranty = 20 years

Authorised Training is available for a small charge, please ask for further details



# FLAT ROOFING - RUBBERGUTTER

RubberGutter EPDM SA is a self adhered, synthetic EPDM rubber waterproofing membrane especially conceived to give gutters a second, very long service life.

Refurbish a wide range of commercial & residential guttering profiles with highly durable & easy to apply Firestone RubberGutter, providing a water-tight gutter lining & extending the life-span of gutters while saving on expensive removal & replacement costs that a typical gutter removal project may otherwise incur.

Suitable for a wide range of gutter types including; Valley, Finlock, Box, Metal, Wood & Concrete Gutters.

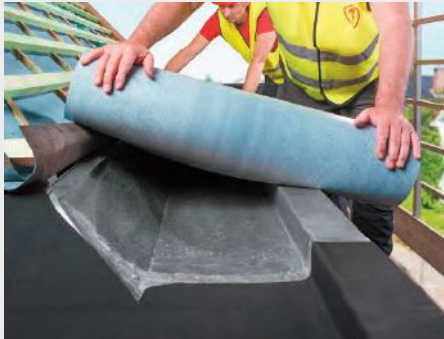

## Firestone RubberGutter

Code	Description	Size
RCG150	EPDM SA Membrane	20m x 1.5m x 1.30mm thick

## Firestone EPDM Prefabricated Drain Insert

Code	Size
RCPDRAIN75	75mm diameter
RCPDRAIN110	110mm diameter

## Firestone Batten Bar

Code	Size
RCTERMBAR	3m Length



## Firestone EasySealant

Code	Size
RCES290	290ml

## Firestone Cleaner C-20

Code	Size
RCAC500	500ml Spray Can

## Firestone QuickPrime Plus Primer

Code	Size
RCQP1	1 litre Can

## Silicone Rubber Roller

Code
RCSRR



# SILICONES & PU FOAM

## POWER PRO SEALANT GUN

- Heavy duty gun with extra pull trigger, hook end and swivel action barrel for both
- 310ml and 400ml cartridges



Code SGPOWER

## DESIGN FOAM GUN

- Heavy duty metal foam gun
- Professional quality



Code PFGUN

## RETRACTABLE KNIFE

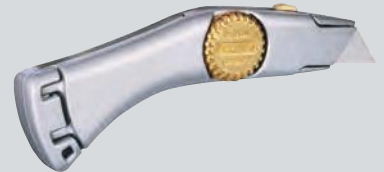

Code STA210122

## 10 BLADES CARDED



Code STA211921

## GLAZING SHOVEL

Allows controlled vertical lift for wedging and 'heel and toe' on double glazed units



Code GLSHOVEL

## 6-IN-1 DECORATOR'S TOOL



Code ELDECT6IN1

## TRADE ESSENTIALS GASKET SHEARS

- 45° faces
- Cuts neatly through rubber gaskets and small PVC-U trims
- Slices cleanly through plastic, rubber and wood up to 15mm thick

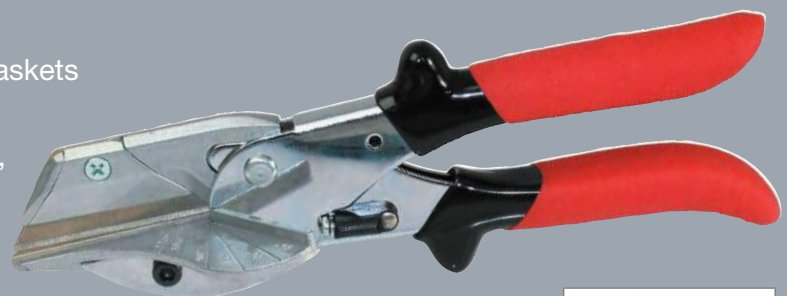

Code ELGASKSH

# SILICONES & PU FOAM

## SILIRUB 2

Colours available:  
White, Clear and a  
range of Colours



Code SILI2

300ml

## SILIRUB LMN

Colours available:  
White, Clear and a  
range of Colours



Code SILILMN

300ml

## SILIRUB N



Code SILI2RUBN

300ml

## SOUDALEAD LEAD SEALANT



Code SLEADPB

300ml

## PVCU GAP FILLER



Code GAPFILLER

300ml

## PROFESSIONAL COX GUN



Code PPCOX400

## SOUDAL WINDOW & DOOR XTRA



Code SOUDAFOAMXTRA

750ml

## SOUDAFOAM GUN PU FOAM



Code SGF750

750ml

## PROFESSIONAL PU FOAM GUN



Code PFREDGUN



**FIX ALL IS A RANGE OF ALL-ROUNDER SEALANTS AND ADHESIVES, SUITABLE FOR A WIDE VARIETY OF APPLICATIONS – NO PRIMER REQUIRED!**



### FIX ALL CRYSTAL

- 100% crystal clear
- Ideal for kitchens, bathrooms and flooring

CL Clear

Code FIXALLCRYSTAL

290ml

### FIX ALL FLEXI

- High elasticity and strength

WH White

Code FIXALLCLASSIC

290ml

### FIX ALL HIGH TACK

- Super strong
- 320kg/10cm<sup>2</sup>
- Ideal for heavy materials ie. mirrors

WH White, BK Black, GY Grey

Code FIXALLHITACK

290ml

### FIX ALL TURBO

- Super fast – 20-min bond!
- End bond in 3 hours

WH White

Code FIXALLTURBO

290ml

### FIX ALL EXTREME

- Ultimate grab, 400kg/m<sup>2</sup>
- Heavy duty bonding
- Ideal for sheet material, decor cladding, heavy objects

WH White

Code FIXALLXTR

290ml

### FIX ALL HIGH TACK INVISIBLE

- High initial tack reducing the need for initial support
- Super clear

IN Invisible

Code FIXALLINVHITACK

290ml

# FLAT ROOF - WATERPROOFING LIQUID

## ULTRA-FLEX HIGH PERFORMANCE LIQUID WATERPROOFING



**New QUICK-CURE**  
Can be used to speed up the curing process and  
**COMPLETE THE JOB IN 1 DAY!**

### FEATURES & BENEFITS

Ultra Flex is a single component liquid that cures through moisture contact and therefore is used directly from the container with no requirement for additional additives.

It is ideal for	Benefits include
New roofs	Pre-mixed
Repair or refurbishment of existing roofs	Excellent adhesion to most surfaces
Flat & low pitched roofs	Early rain resistance
Complex detailing	Cold weather application
Box Gutters and Valleys	Easy wet-on-wet application
	Easy to use with detail and awkward areas
	Flame/heat free application
	Highly elastomeric
	Reinforced & seamless
	From small domestic to large commercial roofs
	Balcony systems available

**Guarantees**  
available from  
**15 to 25 years**

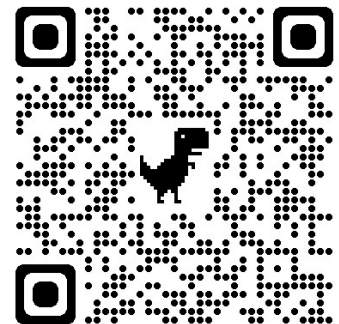



## High performance liquid waterproofing system

Code	Description	Size
EAGLEUDG15KG	Ultra-Flex dark grey 15kg	15kg
EAGLEUM60M	Ultra-Flex matting 60mtr x 1mtr	60m x 1m
EAGLEUM20M	Ultra-Flex matting 20mtr x 1mtr	20m x 1m
EAGLECT2.5	GRP Checktrim - Non Drip 2.5mtr	2.5m
EAGLEDT2.5	GRP Driptrim - Drip 2.5mtr	2.5m
EAGLE9S9"	Ultra-Flex sleeve	9"
EAGLE4S4"	Ultra-Flex sleeve (10 pack)	4"
EAGLE9A9"	Caged roller arm	9"
EAGLEPCND	Preformed corner non drip	N/A
EAGLEDCL	Driptrim to checktrim Left hand corner	N/A
EAGLEUP	Ultraflex Primer	5kg
EAGLEDCR	Driptrim to checktrim Right hand corner	N/A
EAGLE4A4"	Roller arm	4"
ULTRATOP	Ultratop	5kg
ULTRAPCD	Preformed Drip Corner	N/A
TUB11L	Ultraflex Storage Tub + Lid	11L
UT	Tixal additive for vertical applications	1L
UQC	Quick-Cure additive to speed up curing process	1.2L
EAGLEST	Ultraflex Gap filler and sealant	290ml



# FLAT ROOF - WATERPROOFING LIQUID

## FLAT ROOF WATERPROOFING - PRO GRP

### PRO GRP

No Joints, No Seams,  
No Leaks



HEAT  
RESISTANT



FOOT  
TRAFFIC



FIRE  
RESISTANT



FROST  
PROOF



STORM  
PROOF



IMPACT  
RESISTANT

ASK  
IN-BRANCH  
ABOUT GRP  
TRAINING



**CROMAR**  
Building Products

**GRP stands for Glass Reinforced Polyester, and is also known as Glass-Fibre.**

This system is cold applied on site, giving it a seamless and flexible weatherproof finish that resists water, heat and frost. The resulting surface gives a strong architectural finish that looks very impressive. If maintained properly it will last as long as the building stands.

Cromar have developed this technology further to produce the perfect all-weather protection for any flat roof. PRO GRP can be applied in small domestic situations right through to large industrial environments.

The PRO GRP system is available in individual component form allowing the flexibility to buy exactly what's required for your next GRP roofing job.





## PRO GRP

Code	Description
G25/RES10	Pro 25 Resin 10kg
G25/RES20	Pro 25 Resin 20kg
G25/TOP10	Pro 25 Topcoat 10kg
G25/TOP20	Pro 25 Topcoat 20kg
GA/25	Acetone 25l
GA/5	Acetone 5l
GA/C1	C1 Universal External Corner Trim
GA200/RSdT-1	Fascia Trim – A200 3m
GB/ROLL	Glass Fibre Bandage 100mm 3.5kg
GB/ROLL75	Glass Fibre Bandage 75mm 3.5kg
GB260/RSRT-2	Raised Edge Trim - B260 3m
GBB/140	Bubble Buster V Roller 140mm x 21mm
GBB/225	Bubble Buster V Roller 225mm x 21mm
GBB/225/40	Bubble Buster V Roller 225mm x 40mm
GBB/70	Bubble Buster V Roller 70mm x 21mm
GC100/RSLT-1	Simulated Lead Trim - C100 3m
GD260/RSAT-1	Wall Fillet Trim - D260 3m
GDISP/80	Dispenser Bottle 80ml
GEXP	Expansion Joint/Roll Top Trim 3m
GEXT/195/RS/INT	External Angle Trim - Ext/195 3m
GF300	F300 Flat Sheet 20M Roll
GFILL/3	3" Roller Refill
GFILL/7	7" Roller Refill
GFILL/9	9" Roller Refill

## PRO GRP

Code	Description
GH/1	Hardener 1l
GH/5	Catalyst Hardener 5kg
GINT/195.RS/INT	Internal Angle Trim - Int/195 3m
GMAT/	Fibreglass Matting Csm 450gsm 16.5kg
GMAT/15	Fibreglass Matting Csm 450gsm 6.75kg
GMAT/35	Fibreglass Matting Csm 450gsm 35kg
GMAT/35600	Fibreglass Matting Csm 600gsm 35kg
GPAD/140	140mm x 21mm Laminating Paddle
GPAD/225	225mm x 21mm Laminating Paddle
GPAD/70	70mm x 21mm Laminating Paddle
GPB/2	2" Laminating Brush
GPB/3	3" Laminating Brush
GPB/4	4" Laminating Brush
GROLL/3	3" Resin Applicator Roller
GROLL/7	7" Resin Applicator Roller
GROLL/9	9" Resin Applicator Roller
GRP/KIT13B	Grp 13Sqm Kit
GTISH	Grp Finishing Tissue 100mm x 250m
MPHM/031	Pu Adh Grp Trim Adhesive 310 mil
OSB2400X1200X18	2400mm x 600mm x 18mm T&G OSB3 Board
EMPTY/10	10l White Plastic Tub
EMPTY/501	5l White Plastic Tub

# FLAT ROOF - WATERPROOFING LIQUID

## FLAT ROOF WATERPROOFING - FLEXIGLASS GRP



Acrypol Flexiglass® is a versatile grp resin roof system designed for new and existing roofs.

Flexiglass® can be applied to almost any roof surface such as felt, asphalt, concrete and OSB3 TG board as a new roof covering. Flexiglass® is a totally seamless, highly flexible roof system ideal for any sized job.



### Flexiglass Resin

Code	Size
G20FLEXITC20	20kg



### Flexiglass Encapsulating Primer

Code	Size
G20FLEXIPRIMER5	5kg



### Flexiglass BPO Catalyst

Code	Size
G20BPO50	50kg
G20BPO100	100kg
G20BPO200	200kg



### Flexiglass Matting

Code	Size
GMATT/225/6.75	6.75kg (30m approx)
GMATT/225/16.5	16.5kg (73m approx)
GMATT/225/33	33kg (146m approx)

### Flexiglass Joint Bandage



Code	Size
GMAT/225BAN	6.75kg (30m approx)





# Flexiglass<sup>®</sup> 2022

GRP Multi Surface Overlay System



#### ADVANTAGES:

- Flexible GRP for all types of common roofing substrates
- One resin for both base & topcoat
- Quick cure primer
- Uses a 225G chopped strand matting for the ultimate in flexibility
- Health & Safety conscious catalyst with easy application
- Suitable for both new decks & refurbishment projects
- Superior adhesion
- Unaffected by direct sunlight
- Approved contractor scheme
- 20 Year product warranty



Units 3,4,5 Northside Industrial Park,  
Whitley Bridge, DN14 0GH  
Tel: 01977 663 133 Fax: 01977 662 186  
Web: cromar.uk.com

For more information please visit:  
[www.cromarbuildingproducts.com/acrypol-flexiglass/](http://www.cromarbuildingproducts.com/acrypol-flexiglass/)  
or scan the code.



# FLAT ROOF - WATERPROOFING LIQUID

## FLAT ROOF WATERPROOFING - HPX



### FEATURES & BENEFITS

Dark grey colour

Instantly waterproof even when it's raining - applies flawlessly to damp surfaces

Use it straight out of the tin - no mixing/no additional hardener

Applies to most common substrates - rubber, concrete, grp, asphalt

**TriRoof HPX is the ultimate Roofing Overlay System, designed to work all year round from the colder, wetter months and throughout the heat of the summer.**

TriRoof HPX can be applied effortlessly on nearly any surface and even on wet or damp substrates, meaning you don't have to plan your work around the weather.

Once fully cured, HPX remains elastic and can stretch up to 300% of its original size, meaning any movement in the surface will not split or tear the membrane.

For an even tougher, more resilient roof, a layer of glass matting can be incorporated into the liquid to help bind the roof together. HPX is waterproof, UV resistant and has a 10 year guarantee. Adding a second layer with the HPX reinforcement kit will guarantee your roof for 20 years.

This product is cold applied and requires no additional hardener or mixing. It can be applied straight out of the tin. HPX is free of bitumen, solvent and isocyanates, making it kinder to the environment and its users.



Code	Description	Size
HPX	HPX Dark Grey	14kg
HPX10KIT	10 Sqm kit - package description	10m <sup>2</sup>
HPX20KIT	20 Sqm kit - package description	20m <sup>2</sup>

### 10m kit

10m<sup>2</sup>  
 225g HPX Glass Matting  
 Glass Bandage 5m  
 1x6" Smooth Finish Roller  
 1x6" Base Roller  
 1x6" Roller Handle  
 1x6" Roller Handle

### 20m Kit

20m<sup>2</sup>  
 225g HPX Glass Matting  
 Glass Bandage 10m  
 1x10" Smooth Finish Roller  
 1x10" Base Roller  
 1x10" Roller Handle  
 1x10" Roller Handle



# FLAT ROOF - WATERPROOFING LIQUID

## FLAT ROOF WATERPROOFING - ACRYPOL



THE ORIGINAL INSTANT WATERPROOF SOLUTION FOR EMERGENCY LEAKS & FAILING FLAT ROOFS.

Refurbish failed industrial, commercial or domestic flat roofs

Easy to apply

Single coat application

Can be applied even during damp weather conditions

Fibre reinforced

The original instant waterproof solution for emergency leaks & failing flat roofs. Acrypol+ is a total roof coating waterproof system developed to refurbish failed industrial, commercial or domestic flat roofs and is also ideal for general property maintenance as well as patching repairs. Brush applied as a semi liquid paste; it dries to form an ultra-tough, seamless flexible overlay. Acrypol + known as the original waterproof coating, can be applied during damp weather conditions and still provide a long-term solution to waterproofing problems, including flat roof repair.

Acrypol+ can be applied during damp weather conditions and at the same time provide a long-term solution to the problem. The all-weather application properties, combined with the simplicity of application, makes this product a particularly attractive proposition to those employing their own labour force for general property maintenance. The versatility of Acrypol+ is acknowledged widely by Municipal Authorities and Maintenance Contractors throughout the United Kingdom.

### How does Acrypol+ work?

Acrypol+ is an acrylic resin dispersed in a solvent to form a semi-liquid paste. The coating film dries into a tough durable elastic overlay that prevents the passage of water yet is chemically structured to allow trapped moisture to evaporate, thus avoiding the formation of blisters. A specific feature is incorporated with added fibres, fibres that act like a built-in scrim. These fibres interlace when the coating is applied – filling and bridging gaps and cracks (up to 10mm wide). The fibres increase the tensile strength of the dry film making it more durable - a big plus!

- One-coat instant waterproof coating
- Dry and damp application

### Can be used on a variety of surfaces:

Flat Roofs, Asphalt, Bituminous surfaces, Brickwork, Gutters, Leadwork, Metals, PVC, Asbestos, Glass, Roofing felt, Rooflights, Concrete, Fibreglass.

**Coverage:** 1-2kg/m<sup>2</sup> average

**Drying time:** 2-3 days depending on ambient temperature and ventilation

**Colour Options:** GRY Medium Grey, BLK Black

Acrypol+  
5kg



Code	Description	Size	Colour
ACRYPOLGRY	Acrypol+ Roofing Liquid Patch Repair	5kg	Grey
ACRYPOLBLK	Acrypol+ Roofing Liquid Patch Repair	5kg	Black

# FLAT ROOF WATERPROOFING - TRIMS

## FLAT ROOF WATERPROOFING - GRP TRIMS

	Code	Description
1	GA200/RSDT-1	Fascia trim – A200 3m
2	GA250/RSDT-1	Fascia trim – A250 3m
3	GEXT/195/RS/INT	Raised edge trim - B260 3m
4	GINT/195.RS/INT	Simulated lead trim - C100 3m
5	GB260/RSRT-2	Wall fillet trim - D260 3m
6	GC100/RSIT-1	Internal angle trim - int/195 3m
7	GD260/RSAT-1	External angle trim - ext/195 3m
8	GA/C1	C1 universal ext corner trim std
9	GF300	Expansion joint/roll mop trim 3m
10	GEXP	F300 flat sheet 20m roll

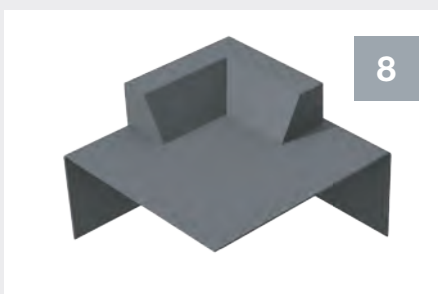
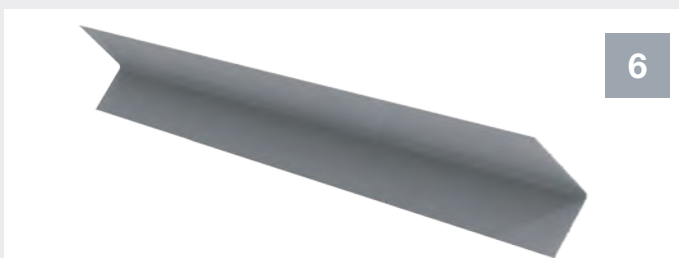
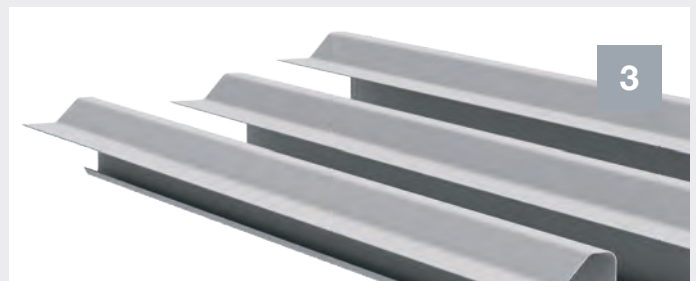
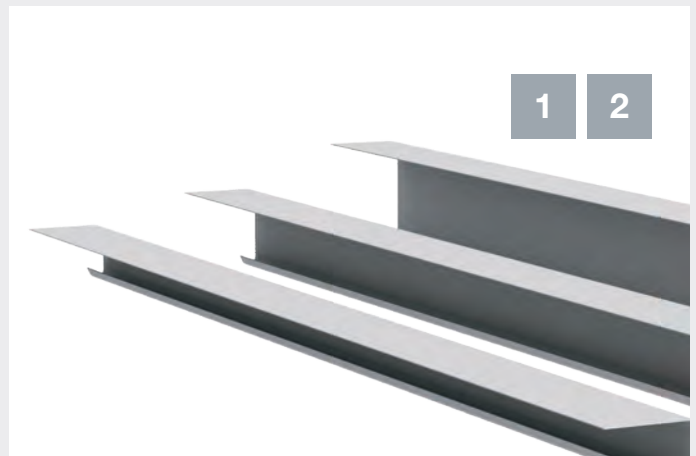



# ROOFING MEMBRANE

## Easy-Trim Grafter Breather Membrane

A lightweight hybrid breathable roof underlay. Suitable for Warm and Cold roof application.



Code	Weight	Size
MEMBGRAFT50M	100gsm	1 x 50m
EASYTRIMGRAFT1.5	100gsm	1.5 x 50m

## Easy-Trim Master Breather Membrane

Master delivers performance and value for money whilst being lightweight and flexible. Suitable for Warm and Cold roof application.



Code	Weight	Size
EASYTRIMMAST1x50	112gsm	1 x 50m
EASYTRIMMAST1.5x50	112gsm	1.5 x 50m

## Easy-Trim Pro Breather Membrane

Pro delivers performance and strength whilst still having a relevant price for most budgets. Suitable for Warm and Cold roof application.



Code	Weight	Size
MEMBPRO50M	122gsm	1 x 50m

## Easy-Trim Maxi Breather Membrane

Maxi provides high performance with a heavier weight for strength, durability, and no gusting wind noise in all applications. Suitable for Warm and Cold roof application.



Code	Weight	Size
EASYTRIMMAXI15	132gsm	1 x 50m

## Easy-Trim Ultra Breather Membrane

Ultra provides further high performance with a heavier weight for strength, durability, and no gusting wind noise in all applications. Suitable for Warm and Cold roof application.



Code	Weight	Size
EASYTRIMULTRA1M	142gsm	1 x 50m
EASYTRIMULTRA15	142gsm	1.5 x 50m

## Easy-Trim Fortis Breather Membrane

Fortis is a 4-layer reinforced heavyweight membrane. Complete with a built-in reinforcement grid. Suitable for Warm and Cold roof application.



Code	Weight	Size
EASYTRIMFORT1.5	160gsm	1.5 x 50m

## Easy-Trim Non-Breath

Non-Breath is a 2-layer, non-breathable roof membrane. Non-Breath roofing membrane provides major benefits over 1F bitumen-based underlays and plastic under slating membrane. Typical applications are re-roofing projects, garages, and porches.



Code	Weight	Size
MEMBPRO45M	120gsm	1 x 45m

## Easy-Trim Vista Breather Membrane

Vista provides ultimate high performance with a real heavy-duty weight for strength, durability and no gusting wind noise in all applications. Suitable for Warm and Cold roof application.



Code	Weight	Size
MEMBVISTA50M	162gsm	1 x 50m

Also available to order from Eurocell branches are the integrated tape range of membranes

# TRACER<sup>®</sup>

PROFESSIONAL CONSTRUCTION MARKERS

# IN STORE NOW

## MINI MARKER

The TRACER black mini permanent marker is ideal for general purpose marking and with lanyard compatibility makes for a convenient marking solution.



- 1-2mm bullet point marker
- Lanyard compatible for convenient marking
- Quick drying ink



## PROSCRIBE

The TRACER proscribe has multiple functions which include, parallel marking, profile scribing, compass and more. This set includes tracer deep hole pencil with site holster, 6 replacement leads and carry case.



- Versatile, lockable design for multiple applications
- High quality, durable metal and plastic construction
- Compact and lightweight and easy to use

15+  
MARKING  
APPLICATIONS



SCAN  
FOR  
MORE  
INFO



- Made from CNC Aluminium
- Metric ruler on plumb edge
- Lockable adjustable arm
- True 90° angle

## ADJUSTABLE PROSQUARE

The TRACER ProSquare is the fastest and simplest tool for marking out; com, jack, hip and valley cuts. Simply set to the roof pitch, with no need to convert or calculate. Available in 7" and 12".

LOOK  
OUT FOR  
TRACER IN  
STORE



SCAN  
FOR  
MORE  
INFO





# ACCESSORIES



## Tracer

Code	Description	Qty
TRC-ADP2	TRACER Deep Pencil Marker & Site Holster	1
TRC-AMP2	TRACER Double tipped Marker Pen & Site Holster	1
TRC-ALH1	TRACER Lead Holster - 6x Replacement leads in TRACER Holster (4x 2B & 2x Yellow)	1
TRC-ACF-MK3	TRACER Clog Free Marker Kit - 3pc pack (1x Black / 1x Blue / 1x Red) c/w Site Holsters	1
TRC-APMK1	TRACER Pack of 4x Permanent Marker's (Black, Red, Blue)	1
TRC-APM1	TRACER Permanent Construction Marker (Black)	1
TRC-APM2	TRACER Permanent Marker (Blue)	1
TRC-APM3	TRACER Permanent Marker (Red)	1
TRC-AHD1	TRACER Heavy Duty Marker - (Black)	1
TRC-APT1	TRACER Paint Marker - (Yellow)	1
TRC-APT2	TRACER Paint Marker - (White)	1
TRC-APST2	TRACER Scribe Tool c/w Deep Hole Pencil & 6x Replacement lead holster	1
TRC-APS12	TRACER 12" Pro Square	1
TRC-H8MAK	TRACER Smart Blades	1

**GET A TRADE ACCOUNT TODAY ASK IN BRANCH FOR MORE DETAILS**



**OVER 6000  
PRODUCTS AVAILABLE  
IN-BRANCH**



**210+ BRANCHES  
NATIONWIDE**



**INSTANT TRADE CREDIT  
AVAILABLE**



**DEDICATED  
ACCOUNT MANAGER**



**EXCLUSIVE TRADE  
ACCOUNT PRICING**



**ONLINE TRADE  
ACCOUNT**

# TIMBER



## OSB3



Code	Pack qty	Size
TSOBB39	1	2440 x 1220 X 11mm
OSB2400X600X18	1	2400 x 600 x 18mm
OSB2400X1200X18	1	2400 x 1200 x 18mm
OSB2440x1220X18	1	2440 x 1220 x 18mm

## Treated roof battens



Code	Pack qty	Size
BATTEN19X38X4.2	1	19 x 38 x 4.2m
BATTEN25X38X4.2	1	25 x 38 x 4.2m
BATTEN25X38X4.8	1	25 x 38 x 4.8m
25X50X4.2BATTEN	1	25 x 50 x 4.2m
BATTEN25X50X5.1	1	25 x 50 x 5.1m
25X50X4.8BATTEN	1	25 x 50 x 4.8m

## Structural Timber



Code	Description	Pack qty	Size
C24TIMBER47X75T4.8	Treated	1	4"x2"x4.8m 47 x 75mm x 4.8m
C24TIMBER47X75UT	Un-Treated	1	4"x2"x4.8m 47 x 75mm x 4.8m
CLS4X2	Treated	1	4"x2"x4.8m 47 x 75mm x 4.8m
CLS4X2T	Un-Treated	1	4"x2"x4.8m 47 x 75mm x 4.8m

## Plywood



Code	Pack qty	Size
PL2440X1220X12	1	2440 x 1220 x 12mm
EQPLY-LM	1	External Plywood 2440 x 1220 x 12mm



# SAWS & BLADES

## TRADE ESSENTIALS 20" PREDATOR PVC-U SAW



- Ideal for cutting PVC-U and other hard plastics
- Precision cut for a fine finish
- Comfort handle
- Rigid blade
- Duralife technology

# PREDATOR™

Code	Size
B98UPVC	20"

### 20" PREDATOR UNIVERSAL SAW



Code B9822

### 20" PREDATOR LAMINATE SAW



Code B98LAMINATE

### BAHCO TOOLBOX SAW



Code BAH30014

### IRWIN 20" PANEL SAW



Code JAK880UN20

### FOLDING KNIFE



Code SJ1750

### STANLEY KNIFE



Code STA210099

# INSULATION



## Knauf earthwool loft roll 44\* (combi cut)

Lightweight and economic insulation quilt for pitched roofs at ceiling level and suspended timber floors. Earthwool Loft Roll 44 is a flexible low density glass mineral wool quilt which is lightweight, resilient and non-combustible. The rolls are 1140mm wide and partially perforated to produce either 2 rolls 570mm wide or 3 rolls 380mm wide or available in ready-cut version (2x570mm only).

Code	Size
LOFTROLL44	150mm
LOFTROLL44200	200mm

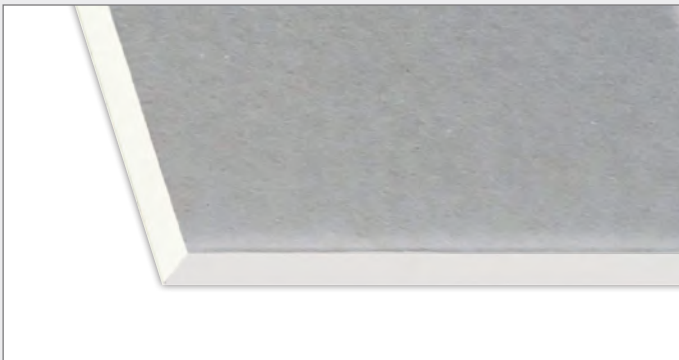

## KNAUF WALLBOARD\*

Strong and versatile, Wallboard is a cost-effective choice for partitions, linings and ceilings with standard performance requirements. Wallboard has an ivory paper face ideally suited for a plaster finish or for direct decoration.

Code	Size
WALLBOARD125	1800 x 900 x 12.5mm

\*Available in selected branches

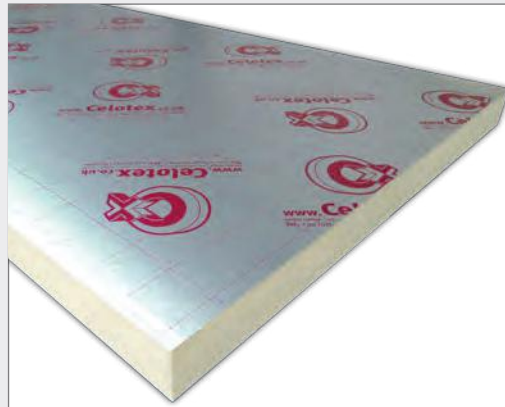

## Celotex insulation\*

Celotex GA4000 is a general purpose insulation board suitable for a variety of applications, including roof, wall and floor insulation. This multipurpose PIR insulation has an A+ rating when compared to the BRE Green Guide.

### Celotex GA4000

Code	Size
INSUL25	2400 x 1200 x 25mm
INSUL50	2400 x 1200 x 50mm
INSUL75	2400 x 1200 x 75mm
INSUL100	2400 x 1200 x 100mm
INSUL120	2400 x 1200 x 120mm



Celotex PL4000 is a high performance thermal insulation board where the PIR insulation is bonded to tapered edge plasterboard.

### Celotex PL4000

Code	Size
INSULPL65	2400 x 1200 x 65mm + 12.5mm



# ACTIS INSULATION

## Actis Hybris

Hybris is an insulation material for timber frame or masonry walls, pitched roofs or ceiling applications. Hybris is a reflective insulation product based on a honeycomb structure.

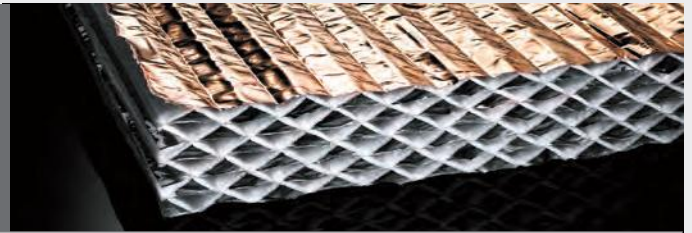

Code	Size
HYBRIS50	1200 x 1145 x 50mm
HYBRIS90	1200 x 1145 x 90mm
HYBRIS105	1200 x 1145 x 105mm
HYBRIS125	1200 x 1145 x 125mm



## Actis Boost'r Hybrid

Boost'r Hybrid is a reflective breathable membrane with an excellent built-in thermal performance for use on the cold side of the building fabric in roofs and walls. Boost'r Hybrid provides dual properties within a single product: A breathable membrane and insulation, allowing a reduction in the number of installation steps whilst reducing the thickness of the main insulation to achieve the same required U-Value. It can be used in conjunction with any type of insulation.

Code	Size
ACTISB35	35mm



## Actis HControl Hybrid

HControl Hybrid is a reflective vapour control layer with a built-in thermal performance for use on the warm side of any insulation material, behind the internal finish in roofs, walls and ceilings. HCONTROL HYBRID provides dual performance within a single product: a vapour control layer and insulation, allowing a reduction in the number of installation steps whilst reducing the thickness of the main insulation to achieve the same required U-Value. It can be used in conjunction with any type of insulation.

Code	Size
ACTISH45	45mm

## Actis tape

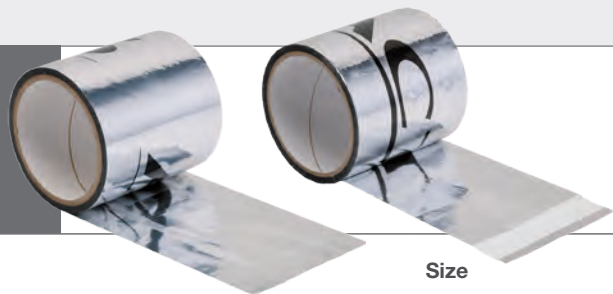

Code	Pack qty	Size
ACTISTAPE150	Tape For Reflective Insulation with Copper or Metalizes Face	100mm x 25m
ACTISTAPEMULTI	HPV Membrane Insulation Tape	100mm x 25m

# ROOFLIGHTS AND GLAZING

## CONTENTS

FAKRO pivoting windows 88

FAKRO flat roof windows 91

Rooflights 92



## ROOFLIGHTS ARE A SAFE & SECURE WAY TO INCREASE NATURAL LIGHT INTO BUILDINGS

- **FAKRO** pivoting roof window  
Comes with inbuilt TopSafe Anti Burglary system, and Head ventilator as standard. P2 Glazing unit with toughened outer pane and laminated inner pane.
- The **FAKRO** type G product range includes flat roof windows which are non-opening (DXG), manually opening (DMG) or electrically operated (DEG).
- **Rooflights** are an ideal way to increase natural light on flat roof properties.

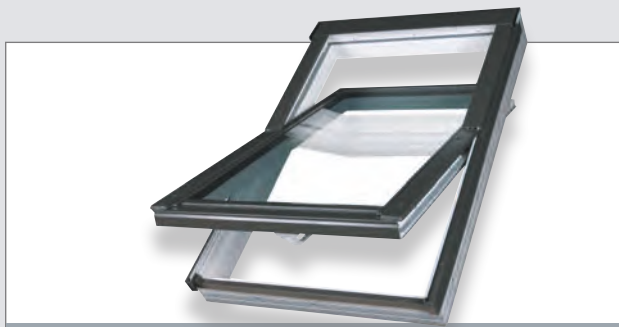

FAKRO pivoting roof windows



Flat roof windows

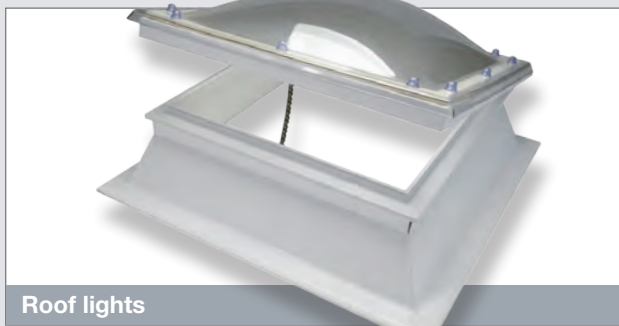

Roof lights

# ROOFLIGHTS

## FAKRO PIVOTING ROOF WINDOW

Comes with inbuilt TopSafe Anti Burglary system, and Head ventilator as standard. P2 Glazing unit with toughened outer pane and laminated inner pane.

Practical and stylish design

Suitable for 15-90 degree pitched roof

U Value of 1.3 W/m<sup>2</sup>K

Noise Reduction 32dB

Fire proof, Conforms with the European standards



FAKRO offer a complete range of premium quality innovative roof window solutions. From pivot roof windows in beautiful designs and clever opening methods, to flat roof windows in various designs and sizes. FAKRO also offer all the accessories needed to fit and furnish roof windows from exterior flashing to blinds.

A full range of compatible blinds and screens are available to order



## FAKRO pivoting roof window

Code	Description
PTP-V01	Pivot Roof Window 55cm x 78cm
PTP-V02	Pivot Roof Window 55cm x 98cm
PTP-V05	Pivot Roof Window 78cm x 98cm
ELV01	Slate Flashing 55cm x 78cm
ELV02	Slate Flashing 55cm x 98cm
ELV05	Slate Flashing 78cm x 98cm
EZV01	Tile Flashing 55cm x 78cm
EZV02	Tile Flashing 55cm x 98cm
EZV05	Tile Flashing 78cm x 98cm





**FAKRO®**



## HIGH PERFORMANCE UPVC ROOF WINDOWS

FAKRO UPVC roof windows are manufactured from materials such as glass, UPVC profiles, aluminium and steel components making them 99% recyclable. Applying recycled components in the production process significantly cuts down the amount of waste and helps reduce the needs for fossil fuels such as crude oil.

Suitable for any space including high humidity rooms such as:

- Bathrooms
- Kitchens
- Wet rooms
- Utilities



AVAILABLE IN



*Special order only*



**10 YEAR WARRANTY**



**EASY TO INSTALL**



**VALUE FOR MONEY**

FIND US AT YOUR LOCAL **eurocell®** BRANCH

[sales@fakrogb.com](mailto:sales@fakrogb.com)

[www.fakro.co.uk](http://www.fakro.co.uk)



# FLAT ROOF WINDOWS

The ideal solution for providing natural daylight

The benefits of natural illumination of buildings are unquestionable but in those with flat roofs it is not always possible to install sufficient standard vertical windows. A source of natural light should be available in any living space to make its occupants feel comfortable. The ideal solution for providing light is the installation of specially designed products for flat roofs.

**ASK IN  
BRANCH FOR  
QUICK TURN-  
AROUND**

**GUARANTEED  
10  
YEARS**





# FLAT ROOF WINDOWS

## FAKRO flat roof windows

- The FAKRO type G product range includes flat roof windows which are non-opening (DXG), manually opening (DMG) or electrically operated (DEG). FAKRO flat roof products bring the very highest standard of natural light to interiors. They also provide ventilation and offer exceptional functionality. In short, they can transform any room under a flat roof.
- The new range of technologically advanced G windows give smart aesthetics and provide an alternative solution for bringing natural daylight into rooms below a flat roof.
- Integral upstand for quick and easy installation.
- P2 safety glazing
- 10 year warranty

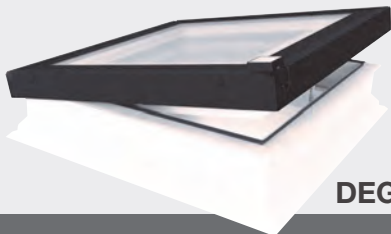

DEG

### Electric z-wave control

- Electrically opened with wireless Z-Wave system,
- Included in the kit: AC adaptor, remote control, rain sensor
- Sash tilts 15cm

Code	Size
FRW80EX01	01K 60x60
FRW80EX02	02K 60x90
FRW80EX03	03K 70x70
FRW80EX04	04K 80x80
FRW80EX05	05K 90x90
FRW80EX06	06K 90x120
FRW80EX07	07K 100x100
FRW80EX08	08K 120x120
FRW80EX09	09K 140x140
FRW80EX10	10K 100x150
FRW80EX11	11K 120x200

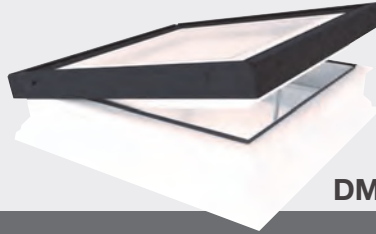

DMG

### Manual opening

- Opened manually by means of ZSD control rod 2.2m long included
- Sash tilts 30cm

Code	Size
FRW80EW01	01K 60x60
FRW80EW02	02K 60x90
FRW80EW03	03K 70x70
FRW80EW04	04K 80x80
FRW80EW05	05K 90x90
FRW80EW06	06K 90x120
FRW80EW07	07K 100x100
FRW80EW08	08K 120x120
FRW80EW09	09K 140x140
FRW80EW10	10K 100x150
FRW80EW11	11K 120x200

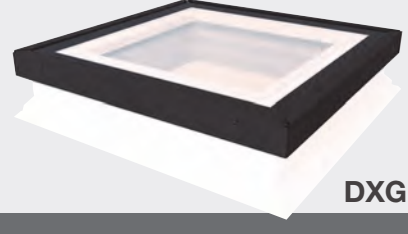

DXG

### Non opening

- Non opening

Code	Size
FRW80EU01	01K 60x60
FRW80EU02	02K 60x90
FRW80EU03	03K 70x70
FRW80EU04	04K 80x80
FRW80EU05	05K 90x90
FRW80EU06	06K 90x120
FRW80EU07	07K 100x100
FRW80EU08	08K 120x120
FRW80EU09	09K 140x140
FRW80EU10	10K 100x150
FRW80EU11	11K 120x200



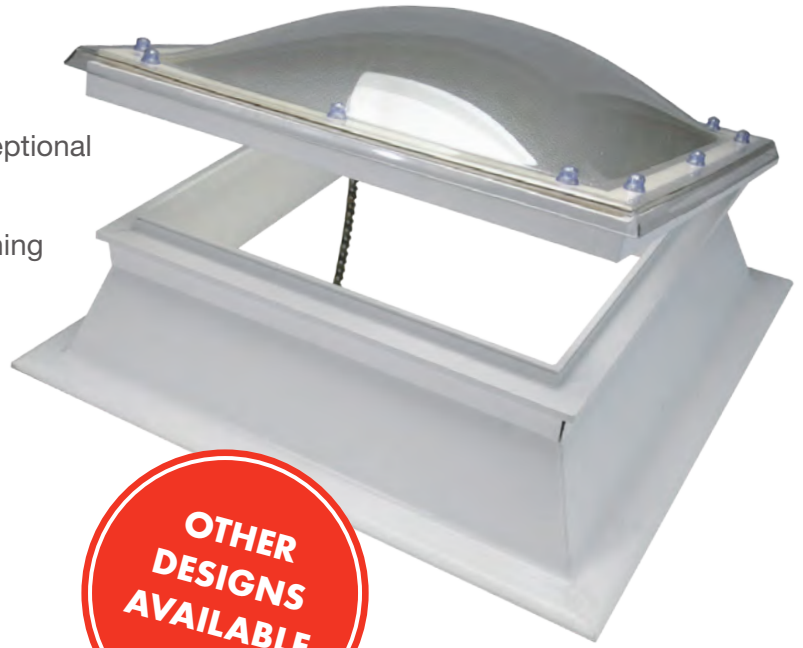

# ROOFLIGHTS

- Rooflights are an ideal way to increase natural light on flat roof properties.
- This product range offers high security and exceptional energy efficiency - with u-values as low as 1.8!
- The domed design offers great aesthetics, meaning they are desirable additions for residential and commercial applications.



**OTHER  
DESIGNS  
AVAILABLE**

## GLAZING OPTIONS

	<b>CLEAR</b>	<ul style="list-style-type: none"><li>• High light transmission</li><li>• Allows unimpeded views</li></ul>
	<b>OPAL</b>	<ul style="list-style-type: none"><li>• High light transmission</li><li>• Allows unimpeded views</li></ul>
	<b>DIFFUSED</b>	<ul style="list-style-type: none"><li>• Maximises privacy</li><li>• Diffuses light to avoid sun glare</li></ul>
	<b>BRONZE</b>	<ul style="list-style-type: none"><li>• Reduces solar heat gain</li><li>• Reduced light-transmission</li></ul>

Choice of ventilation options - ask a member of staff at your **local Eurocell branch today!**

## GET A TRADE ACCOUNT TODAY

ASK IN BRANCH FOR MORE DETAILS



**OVER 6000  
PRODUCTS AVAILABLE  
IN-BRANCH**



**210+ BRANCHES  
NATIONWIDE**



**INSTANT TRADE CREDIT  
AVAILABLE**



**DEDICATED  
ACCOUNT MANAGER**



**EXCLUSIVE TRADE  
ACCOUNT PRICING**



**ONLINE TRADE  
ACCOUNT**



# CLEANING PRODUCTS & FILLER

## CLEANERS

### CREAM CLEANER

- Restore and revive PVC-U surfaces
- Solvent-free



Code CCLEAN1

1 litre

### GLASS CLEANER



Code GCLEAN1 1L

Code GCLEAN25 25L

### SOLVENT CLEANER



Code SCLEAN1 1L

Code SCLEAN5 5L

Code SCLEAN1-10 HEAVY DUTY 1L

## FILLER

### REPAIR EXPRESS PLASTER 900ML

- An ultra lightweight filler for gaps and cracks
- Easy to tool and sand
- Sets hard with no shrinkage or sagging
- Overpaintable



Code SOUDAFIL900

white

## WIPES



- Super strong and soft cloth like fabric
- Cleans up oil, grease, ink, paint, silicones, or uncured PU foam
- Stays wet and useable for over an hour

Code ULTRAGRIME



- Super strong fabric – rough on one side, soft on the other
- 3-in-1 action for efficient cleaning – Lifts, Cleans, Protects
- Stays wet and useable for over an hour

Code ULTRAWIPEPOWER

### 113551 SWIPEX SUPER CLEANING WIPES

- Heavy-duty non-woven wipes
- Multi-purpose use
- Removes oil, sealant adhesive stains, grease etc. from hands



100 pack

# CONSERVATORIES

## CONTENTS

Equinox tiled roof	96
Conservatory roofs	102
Luma flat rooflight	104
Skypod lantern roof	106
Roof Glazing	112
Canopies	121



## A SUPERB SELECTION OF CONSERVATORY ROOFS TO SUIT EVERY HOME, PLUS CONSERVATORY ACCESSORIES AND CANOPIES

- **Equinox tiled roofs**  
transform your customers' conservatories from an under-used room into a cosy, welcoming space that provides complete comfort all year round - find out more on page 96
- **Skypod lantern roofs**  
with a **NEW** acute design option now available, Skypod lantern roofs have never looked better. Why not offer your customers sleek, contemporary design with Skypod today? - find out more on page 106
- **Polycarbonate roof glazing**  
- offers a great cost saving solution to traditional glass options - find out more on page 112





## TILE ROOF SYSTEMS

The Equinox tiled roof is the perfect solution. Combining high-quality precision engineering with attractive styling inside and out

- **Energy efficiency** with new high performance styrene helps boost overall roof energy efficiency and thermal insulation to keep the room below comfortable enough to use at any time of year
- **Structural strength** Upgraded boarding in the roof system sandwich increases overall strength to allow larger areas without risk of sagging
- **No job is too small** - Equinox isn't just a great system for conservatory roofs either. This versatile solution can also be used to transform flat roofs – whether you are building a new extension or you have an existing flat roof that's ready for a change.



## Metrotile steel roof tiles

Steel tiles come as standard, and are lightweight and available in a choice of colours to suit many house styles.

### METROTILE COLOUR OPTIONS



CHARCOAL

ANTIQUE RED

BURNT UMBER

MOSS GREEN

EBONY

## Tapco Classic composite roof tiles

Composite tiles offer the authentic look of traditional slate tiles without the risk of shattering, fading, warping or cracking.

### TAPCO COLOUR OPTIONS



BRICK RED

PEWTER GREY

STONE BLACK

CHESTNUT

PLUM

RED ROCK

### COMPOSITE SLATE TILES COLOUR OPTIONS

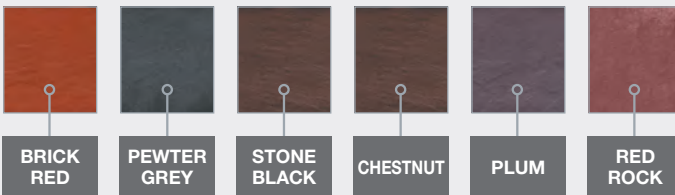

BRICK RED

PEWTER GREY

STONE BLACK

CHESTNUT

PLUM

RED ROCK

## Slateskin sheet tiles

Slateskin tiles are 50% faster to install than steel or composite tiles. That means less disruption for you during installation.



SLATE GREY

### FASCIA COLOUR OPTIONS

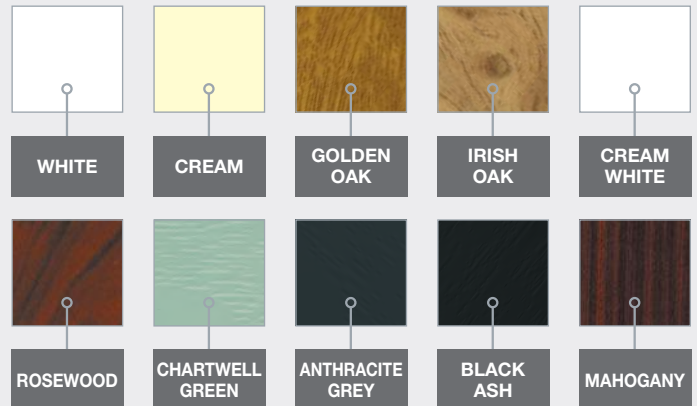

WHITE

CREAM

GOLDEN OAK

IRISH OAK

CREAM WHITE

ROSEWOOD

CHARTWELL GREEN

ANTHRACITE GREY

BLACK ASH

MAHOGANY

### Guttering colours

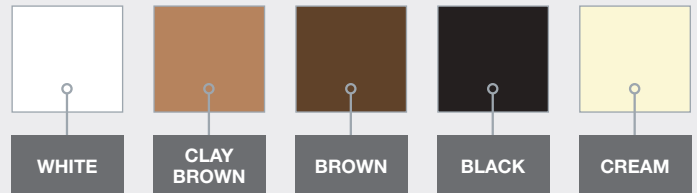

WHITE

CLAY BROWN

BROWN

BLACK

CREAM

### STEEL TILE OPTIONS

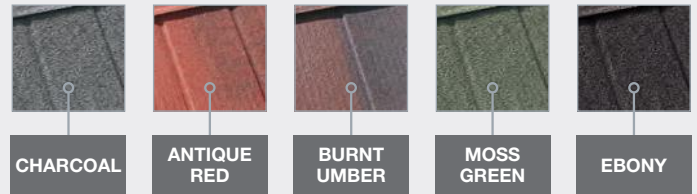

CHARCOAL

ANTIQUE RED

BURNT UMBER

MOSS GREEN

EBONY

### VEGA GLAZING COLOUR OPTIONS

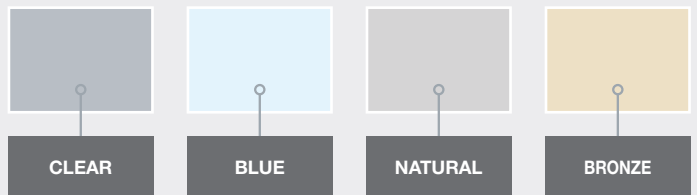

CLEAR

BLUE

NATURAL

BRONZE

## Envirotile lightweight roof tiles

Recycled polymer lightweight roof tile with an interlocking system that makes tiling easier. Available as part of the Equinox tiled roof system.

### ENVIRO TILE COLOUR OPTIONS



SLATE GREY

BROWN

TERRACOTTA

ANTHRACITE GREY

ANTHRACITE BLACK



# TILE ROOF SYSTEMS

The leading system - Eurocell designed, manufactured & distributed

**equinox**<sup>®</sup>  
THE DIFFERENCE IS NIGHT & DAY

**DELIVERED  
IN 5-7  
WORKING  
DAYS**

**0.15  
U-VALUE**



Variable pitches means more conversions possible



Greater structural strength



Easy and quick installation in 2 days



Design-engineered for outstanding technical performance

**0.15  
U-VALUE**

U-values as low as 0.15



Better value for money - helps increase your sales

**FULLY VENTILATED SOLID ROOF SYSTEM WITH EXTRA RIGIDITY**



**WE GUARANTEE UNBEATABLE SERVICE**



Quote requests for conservatory roofs returned in under an hour



Technical support with one point of contact every step of the way



Delivered at a time to suit you - in as little as 3 days



Phone and onsite support with surveys and installation



# ROOF WINDOWS

A choice of high-quality, market-leading roof windows and full glazing panel solutions are available and can be fitted into the roof system.



For more details ask a member of staff at your local Eurocell branch!



**equinox**<sup>®</sup>  
THE DIFFERENCE IS NIGHT & DAY

**equinox**<sup>VEGA</sup>

**GLAZED SOLUTIONS**

**More light**

Equinox Vega features large glazed areas letting in more natural light for brighter, sunlit conservatories that give an impression of even more space.



# TILE ROOF SYSTEMS

**equinox**<sup>®</sup>  
THE DIFFERENCE IS NIGHT & DAY



**BETTER VALUE  
THAN EVER**



**SAVE TIME**



**SAVE HASSLE**



## ROOF STYLES

### HINTS & TIPS

**COMPATIBLE WITH  
ALL ROOF STYLES**

- Victorian
- Edwardian
- Gable-ended
- P-shaped
- Lean-to

**EQUINOX IS ALSO  
SUITABLE FOR:**

- Flat roofs
- Extensions
- Porches



VICTORIAN



EDWARDIAN



GABLE-ENDED



LEAN-TO



P-SHAPED



# DISCOVER MORE... INTERIOR PRODUCTS

SEE THE  
FULL RANGE  
IN THE INTERIOR  
PRODUCT  
SOLUTIONS  
CATALOGUE

## PRODUCT RANGE

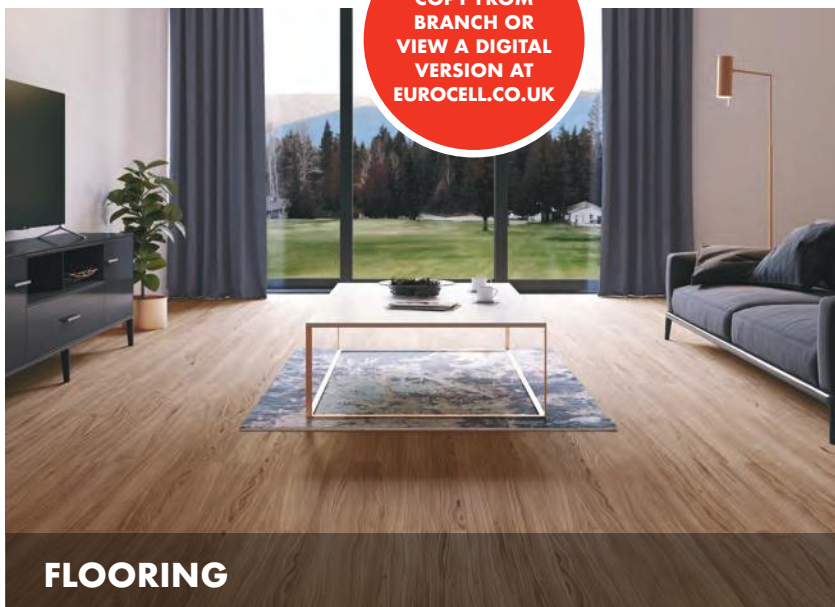

GET YOUR  
COPY FROM  
BRANCH OR  
VIEW A DIGITAL  
VERSION AT  
[EUROCELL.CO.UK](http://EUROCELL.CO.UK)



**OVER 6000  
PRODUCTS  
IN-BRANCH**



**210+ BRANCHES  
NATIONWIDE**



**PRODUCT EXPERTS  
IN EVERY BRANCH**



**FREE SURVEYS  
& QUOTATIONS**



**CLICK & COLLECT  
IN-BRANCH**



**FREE ONSITE  
DELIVERY\***

\*Free onsite delivery on orders over the min. spend - Longer lead times apply to made-to-order items. Applies to mainland UK only and excludes Northern Ireland & Northern Scotland.

# CONSERVATORY ROOFS

## CONSERVATORY ROOFS

Traditional conservatory roofs

- Compatible with all Eurocell systems, including Eurologik and most other window systems
- Adjustable ridge and eaves beam providing a pitch range of 2.5° up to 45°
- One standard capping for 25mm, 32mm polycarbonate and 24mm glass
- Foam ridge sealing assembly
- The ridge cap with finial and cresting is fitted before the polycarbonate
- Lead flashing channel on the starter bar and flashing trim
- Easy to fit bolt on jack rafters
- Adhesive polycarbonate support trim
- Lusso orangery-style internal finish also available

**Fit quicker, more efficiently and smoothly by reducing mitring, scribing and sealing - For more information please call us on 08000 77 88 88 today!**





**FREE**  
**QUOTATION - ASK**  
**IN-BRANCH FOR**  
**DETAILS**



## Conservatory roof system

Eurocell's conservatory roof system is designed to eliminate common problems experienced by installers at a price that doesn't penalise you for wanting to fit the best.



# ROOF STYLES

## HINTS & TIPS COMPLETE THE JOB



### RAINWATER SYSTEMS

Take a look at the range on page 122



### BI-FOLD & PATIO DOORS

Find out more in our Door & Window catalogue



### POLYCARBONATE SHEETS

Choose from our range of polycarb on page 112



### COMPOSITE DECKING

See our full range in our Outdoor Living catalogue

## Stunning styles to suit all homes



VICTORIAN



EDWARDIAN



GABLE-ENDED



LEAN-TO



P-SHAPED

## Roof Glass Colour Options



CLEAR



BLUE



NATURAL



AQUA



BRONZE

# LUMA FLAT ROOFLIGHT

Our new aluminium flat rooflight is designed for now and for future with low-carbon heating and world-leading levels of energy efficiency.

**New**

Luma is built to withstand everything the British weather can throw at it.

Suitable for multiple projects, such as existing or new flat roof extensions, garage conversions, new builds, garden rooms and more.

**Made-to-measure.**

**Available in square and rectangular designs.**

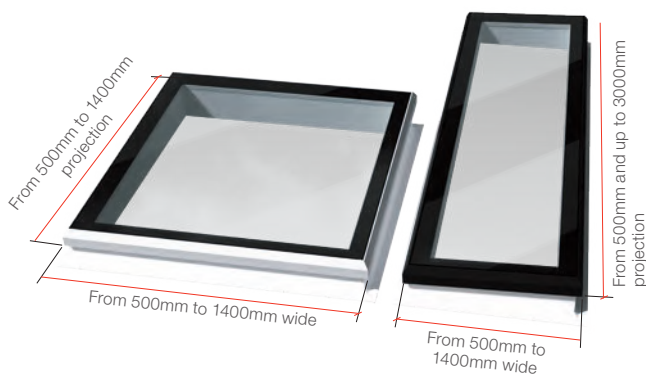

Max glass area 2.5sqm



## Weather-resistant powder-coated frame

The aluminium frame is powder coated for durability and has a UV-resistant, weather-tight seal.



## Tinted laminated glass options

Tinted glass still allows the light to flood in but reduces uncomfortable glare from sunlight.



## Secured from the inside

**Exclusive to Luma**

The only flat rooflight which is fixed from the inside for added security.

## Slimline modern profile with sleek seamless glazing

**Exclusive to Luma**

## FRAME COLOURS

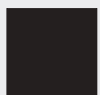

**MATT BLACK**  
RAL 9005



**WHITE**  
RAL 9003



**ANTHRACITE GREY**  
RAL7016



**ANY RAL COLOUR SPRAYED** <sup>2</sup>

## GLASS OPTIONS



**NEUTRAL TINTED**



**BLUE TINTED**

## Easy to install and delivered straight to site

Complete the job quickly, with no fuss and no mess.

### 2-5° installation pitch

Flexible installation options to minimise pooling of water.<sup>4</sup>

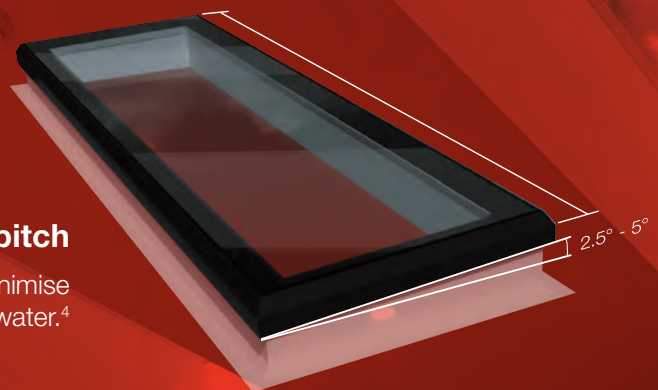

**Quotes in under 1 hour**

There's no waiting around. Just call, drop us an email or fill in the contact form on our website to request a quote, and we'll respond within an hour.<sup>5</sup>



**Lead times to suit you**

Tell us when you need the products to be on site, and we'll ensure they're there at the right time.



**Order checking**

Our orders are thoroughly checked prior to delivery, allowing you to get on with installing Luma right away.



**Technical support line**

Luma flat rooflights are easy to install, but if you need help, ask our experts at your local Eurocell branch or call us on 0333 005 6525.

<sup>4</sup> Installation at 5° pitch is recommended

<sup>5</sup> Applies within normal office working hours: Mon-Fri 8.30 - 17.00



# illuminate your world

**Luma** aluminium flat rooflights

Made-to-measure.  
Easy to install.



**Rigid slimline  
aluminium profile**

The visible framework is minimised, and daylight is maximised.



**Secured from  
the inside**

Fixed from the inside for added security.



**Double or Triple  
glazed options**

Laminated high performance self-cleaning glass.



**Excellent energy  
efficiency**

Thermally broken frame and U-values as low as 0.9.<sup>3</sup>



**10-year guarantee**

For peace of mind.

Order in-branch or online

[eurocell.co.uk/luma](http://eurocell.co.uk/luma)

1. Subject to maximum glass area of 2.5m<sup>2</sup> (double-glazed) / 2m<sup>2</sup> (triple-glazed). May also be subject to Eurocell's handling restrictions.

2. Extended lead times apply

3. U-values of 1.3 W/m<sup>2</sup>K for double and 0.92 W/m<sup>2</sup>K for triple-glazed.

**eurocell**®

# SKYPOD LANTERN ROOF

## SKYPOD LANTERN ROOF

- **Skypod** is available in a wide range of sizes and styles, so you can create a lantern roof that complements the individuality of your home
- Skypod is suitable for a wide range of projects such as flat-roofed extensions, orangeries, new builds, kitchen-diners and garage conversions
- **Enjoy larger glass areas**  
With its clean lines and sleek looks, a Skypod lantern roof will add real height and volume to your room. And thanks to a no side rafter option, you can enjoy unimpeded views
- **An energy efficient solution**  
Skypod can achieve exceptional U-values as low as 1.0\* – this helps minimise heat loss, meaning that you can save money on your heating bills





# SKYPOD

Pitched lantern roofs

**DELIVERED  
IN 5 WORKING  
DAYS - ORDER  
ONLINE  
TODAY!**





## WHY CHOOSE SKYPOD?

Great looks, energy efficient, easy installation and a more cost-effective solution than conservatory roof systems or aluminium skylights - Skypod brings a stylish new living space that's flooded with natural light.



### Skypod Acute

And now, thanks to Skypod Acute - you can increase the natural light of your home in a purpose-designed lantern roof!

	Fast, accurate installation		U-values as low as 1.0*
	A choice of frame and glass colours		Designed for superior performance
			Cheaper than aluminium alternatives

## FREE BROCHURE

See the great benefits of Skypod for yourself in our **NEW Skypod brochure**.



**PICK ONE UP  
IN-BRANCH TODAY!**



# SKYPOD LANTERN ROOF



35 degree roof pitch to maximise light into your home

## Aspirational living spaces

Create an impressive feature on smaller flat roofs and maximise natural light in your home.



## SKYPOD FRAME COLOURS



**WHITE**  
White interior



**ANTHRACITE GREY**  
White interior



**ANTHRACITE GREY\***  
Anthracite interior



**MOONDUST GREY**  
White interior



**ROSEWOOD**  
White interior



**GOLDEN OAK**  
White interior

## GLASS COLOURS



**BLUE**



**NEUTRAL**



**BRONZE**



**AQUA**



**CLEAR**

## SKYPOD PLUS FRAME COLOURS



**MATT BLACK**  
White interior



**MATT BLACK**  
Black interior\*\*



**GREY**  
White interior



**GREY**  
Grey interior\*\*



**WHITE**  
White interior

Additional colours and specifications are made to order on extended lead times

### skypod acute



all Skypods available in 20° and 35° fixed pitches



## skypod<sup>®</sup>

Available in fixed 20°  
and 35° pitches

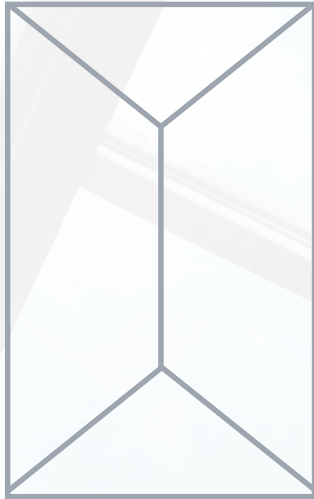

No 'side-bars' needed on  
sizes up to 1.5m x 2.75m



Up to 1.5m x 7.45m

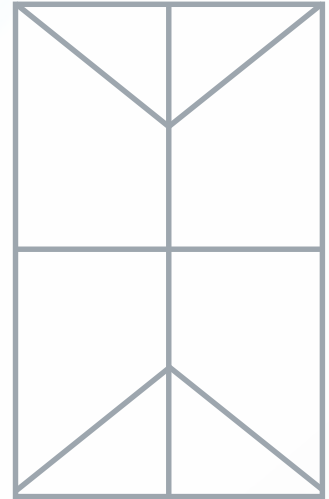

Up to 2.75m x 8.7m

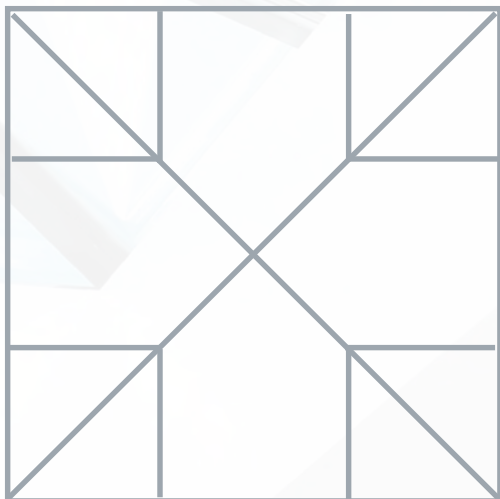

Up to 2.75m x 2.75m

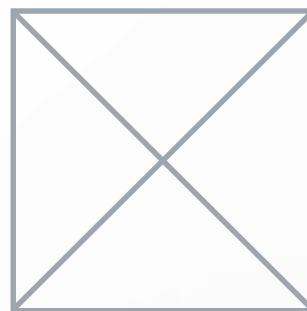

Up to 1.5m x 1.5m

Note: Design will vary dependent on size. All Skypod lantern roofs are made-to-order, and you will receive a design to sign-off before the item goes into production.

# SKYPOD LANTERN ROOF

SKYPOD PLUS

skypod<sup>PLUS</sup>

PREMIUM LANTERN ROOFS



## THE NEW SKYPOD PLUS.

Skypod Plus is a brand new addition to the successful Skypod range. Building on the existing purpose designed thermally broken aluminium ridge and ring beam, Skypod Plus now offers aluminium rafter top caps powder coated in smooth grey and white, to sit alongside the existing black. This means the whole of the external face offers stunning architectural aesthetics. All internal bars are capped in the conventional way with PVC-U and are available in white, grey or black finish.

Skypod Plus is available in 2 or 3 bar options and square shaped. The system has a fixed roof pitch of 20° and is supplied in a choice of five self-cleaning, temperature controlling glass options, with a centre pane U-value of 1.0W/m<sup>2</sup>K achievable.

The contemporary and balanced aesthetics on Skypod Plus have been achieved by avoiding the use of bulky end caps, crestings and finials, which are incorporated into lantern roofs when using standard conservatory components.

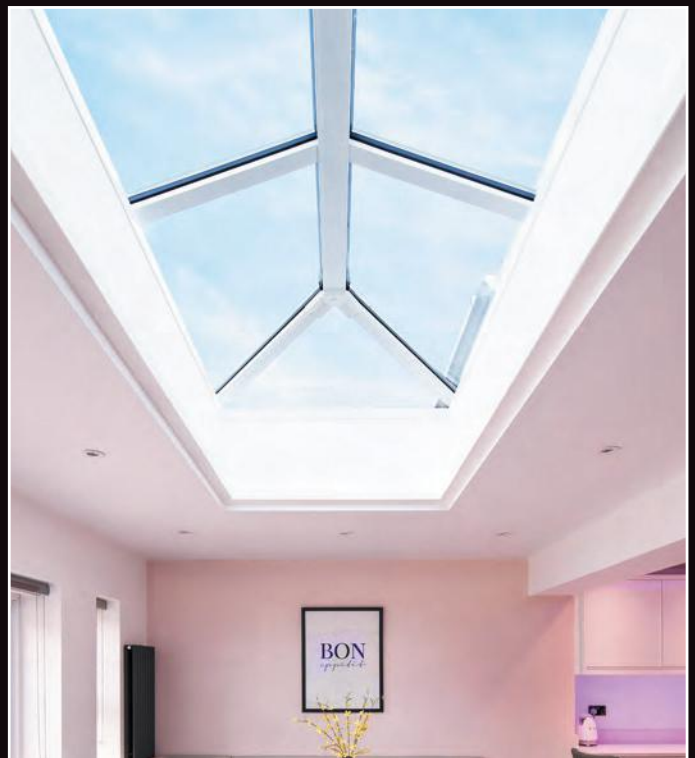





**MATT BLACK**  
White interior

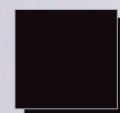

**MATT BLACK**  
Black interior

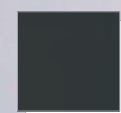

**GREY**  
White interior

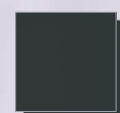

**GREY**  
Grey interior

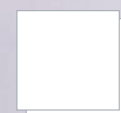

**WHITE**  
White interior

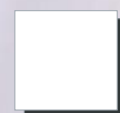

**WHITE**  
Grey interior

**WITH ALUMINIUM RAFTER TOP CAPS.  
AVAILABLE IN BLACK, WHITE & GREY.**

## SKYPOD PLUS STYLE & SIZE OPTIONS

Available  
in 20°  
fixed pitch

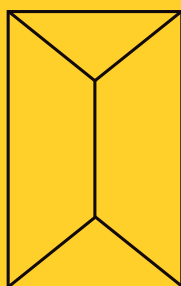

No 'side-bars'  
needed on sizes up  
to 1.5m x 2.75m

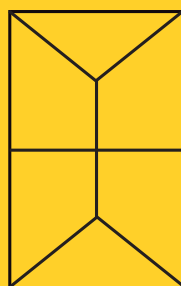

Up to  
1.5m x 7.45m

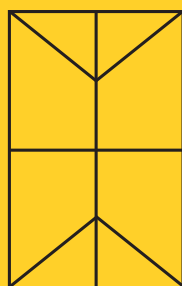

Up to  
2.75m x 8.7m

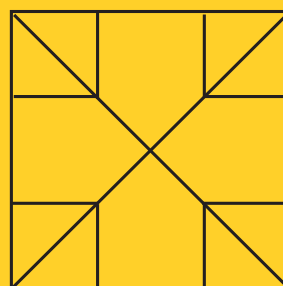

Up to  
2.75m x 8.7m

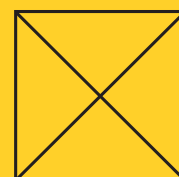

Up to  
1.5m x 1.5m

**Find out more at [eurocell.co.uk/skypodplus](http://eurocell.co.uk/skypodplus)**

\* Black and grey internal finishes on Skypod Plus are produced by a spraying process

## ROOF GLAZING

Standard and bespoke polycarbonate, and roof panel ranges

**POLYCARBONATE SHEETS ARE  
A GREAT ALTERNATIVE  
TO GLASS**

- Ready to use
- Mould resistant
- Suitable for a wide variety of applications including conservatory roofs
- Lightweight and excellent impact resistance
- Weather and UV resistant
- Superb thermal insulation





# POLYCARBONATE



IDEAL FOR USE IN CONSERVATORIES, CANOPIES, CURVED ROOF LIGHTS AND MUCH MORE

Lightweight

Energy saving

Range includes 10mm Twin Wall Polycarbonate and 16mm Multiwall Polycarbonate

Available in Clear and Opal

## POLYCARBONATE SHEETING

Multiwall Polycarbonate is an extensive range of sheeting in various thickness and sizes.

Multiwall Polycarbonate is co-extruded with a full UV protection layer offering high levels of impact resistance. The energy saving, lightweight sheeting is ideal for use in conservatories, canopies, curved roof lights and much more. Our standard range includes 10mm Twin Wall Polycarbonate and 16mm Multiwall Polycarbonate. A bespoke range of sizes can also be ordered in branch.

Multiwall Polycarbonate is the most widely used form of polycarbonate, often used for conservatories and lean-to roofs. The various layers it's made up from provides superb thermal insulation, also providing relatively good sound insulation. For Timber supported roofs we would recommend 10mm to 25mm polycarbonate, whereas 16mm to 35mm polycarbonate for self-supporting roofs.

You can also use polycarbonate for other glazing requirements. Some examples include sport shelters, bike racks and security barriers. This demonstrates the versatility of polycarbonate sheets.

		Light Transmission (%)	
Thickness	U-Value (W/m <sup>2</sup> k)	Clear	Opal
10mm Twinwall	3.2	82	40
16mm Multiwall	2.4	77	42



**SPECIAL ORDER  
DELIVERED IN 7 DAYS**

# POLYCARBONATE POPULAR SIZES

## Twin wall polycarbonate sheet 10mm



Code	Size	Colour
PC10-C700x4000	700 x 4000 mm	Clear
PC10-C700x3000	700 x 3000 mm	Clear
PC10-C1050x4000	1050 x 4000 mm	Clear
PC10-C1050x3000	1050 x 3000 mm	Clear

## Twin wall polycarbonate sheet 10mm

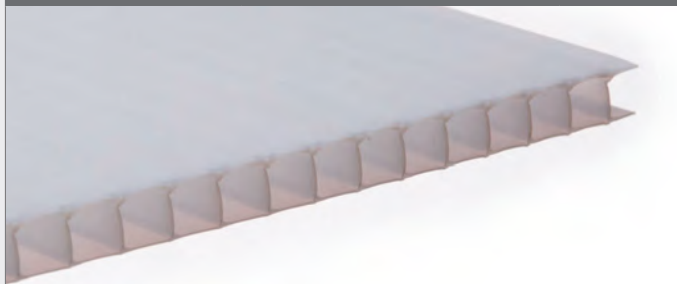

Code	Size	Colour
PC10-O700x4000	700 x 4000 mm	Opal
PC10-O700x3000	700 x 3000 mm	Opal
PC10-O1050x4000	1050 x 4000 mm	Opal
PC10-O1050x3000	1050 x 3000 mm	Opal

## Multi wall polycarbonate sheet 16mm



Code	Size	Colour
PC16-C700x4000	700 x 4000 mm	Clear
PC16-C700x3000	700 x 3000 mm	Clear
PC16-C1050x4000	1050 x 4000 mm	Clear
PC16-C1050x3000	1050 x 3000 mm	Clear

## Multi wall polycarbonate sheet 16mm

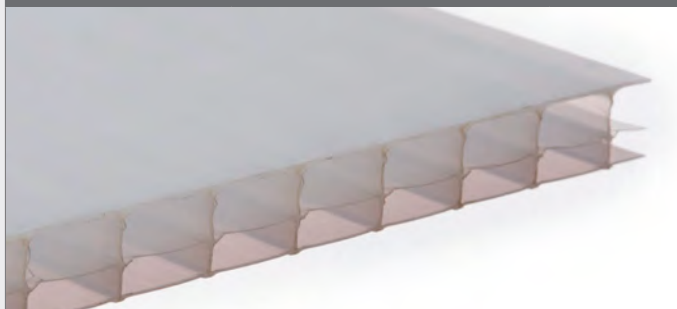

Code	Size	Colour
PC16-O700x4000	700 x 4000 mm	Opal
PC16-O700x3000	700 x 3000 mm	Opal
PC16-O1050x4000	1050 x 4000 mm	Opal
PC16-O1050x3000	1050 x 3000 mm	Opal



# POLYCARBONATE BESPOKE MADE TO ORDER RANGE



## Multi-wall polycarbonate heat-guard opal

A multi-layered dual colour sheet with a co-extruded heat reflective layer in the outer surface reducing the solar transmission by up to 50% compared with standard tint material.

HEAT guard

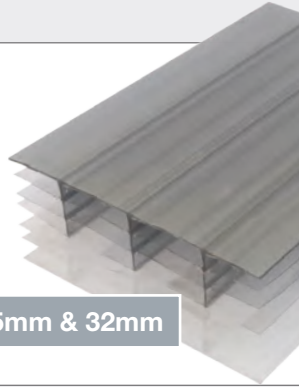

SIZES: 25mm & 32mm

## PERFECT PARTNER

Our nylon hammer is perfect to hammer those end caps into place once you have your polycarbonate in position.



## Multi-wall polycarbonate

Size	Colours
25 & 32mm	Clear



## Multi-wall polycarbonate

Multi-wall offers extra heat and noise insulation, whilst the bronze tint reduces sun glare

Sizes	Colours
10 & 32mm	Bronze/Opal



## Twin-wall polycarbonate

Choose clear twin-wall polycarbonate when maximum light transmission is required

Size	Colours
10mm	Clear



## Triple-wall polycarbonate

Choose clear triple-wall polycarbonate when maximum light transmission is required

Sizes	Colours
16mm	Clear



## Triple-wall polycarbonate

Opal polycarbonate offers protection from sun glare, whilst providing extra privacy

Sizes	Colours
16mm	Opal



## Triple-wall polycarbonate

Bronze polycarbonate has a tinted effect for protection from sun glare

Sizes	Colours
16mm	Bronze

# POLYCARBONATE ACCESSORIES

## Snaptyte glazing bars

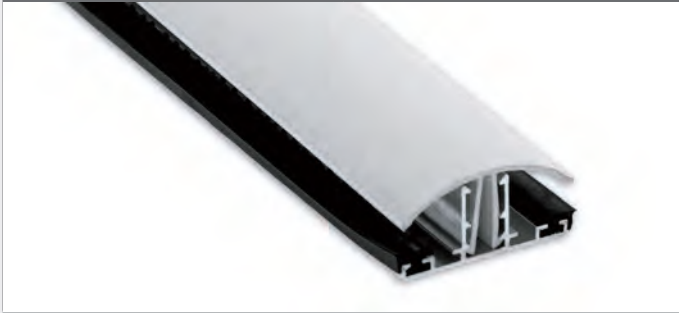

Join polycarbonate sheets with easy fit glazing bars

### Glazing bars

Code	Size
ND25ST25	1 x 2.5m
ND25ST30	1 x 3m
ND25ST40	1 x 4m

### Curled roof edge strip

ND25STRE3	1 x 3m
ND25STRE4	1 x 4m

Colour options: WH White / B Brown

## F profiles

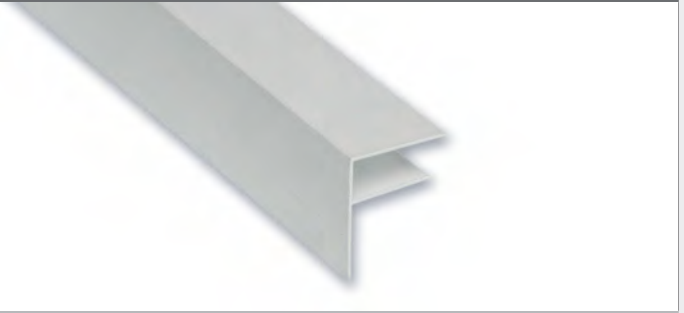

F profiles offer support on a side wall, or act as a neat outside roof trim

### 10mm

Code	Size
ND10F1030	3m x 10mm
ND10F1040	4m x 10mm

### 16mm

ND10F1630	3m x 16mm
ND10F1640	4m x 16mm
ND10F1660	6m x 16mm

Colour options: WH White / B Brown

## Sheet closures



Fit onto polycarbonate ends to prevent water from getting into the roof space

Code	Size
ND10SCB	2.1m x 10mm
ND16SCB	2.1m x 16mm
ND25SCB	2.1m x 25mm

Colour options: WH White / B Brown

## Fixing buttons



10  
pack

For securing polycarbonate sheets when required

Code	Size
PGFB10	10mm
PGFB16	16mm
PGFB25	25mm

Colour options: WH White / B Brown

## Tapes



50m  
lengths

### Solid

Code	Size
ANO3ST45MM	45m

### Vented

Code	Size
ANO3ADT45MM	16mm



### Rafter bar - white



Code	Size
RB40-W	4000mm
RB30-W	3000mm

### Ally F-section - white



Code	Size
10mm	
AF103-W	10mm
AF104-W	10mm
16mm	
AF163-W	16mm
AF163-W	16mm

### Storm tape pack



Code	Size
STP16	16mm
STP10	10mm

## GET A TRADE ACCOUNT TODAY

ASK IN BRANCH FOR MORE DETAILS

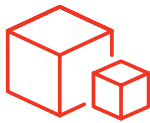

**OVER 6000  
PRODUCTS AVAILABLE  
IN-BRANCH**



**210+ BRANCHES  
NATIONWIDE**

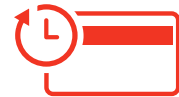

**INSTANT TRADE CREDIT  
AVAILABLE**



**DEDICATED  
ACCOUNT MANAGER**



**EXCLUSIVE TRADE  
ACCOUNT PRICING**



**ONLINE TRADE  
ACCOUNT**

# POLYLOC PANELS



## THE DIY EASY-FIT, INSTANT ROOF SOLUTION

Lightweight

No glazing bars

Speedy assembly, no specialist tools are required

The panels are manufactured from impact resistant polycarbonate

Hardwearing, durable and long-lasting materials

Easy installation

## POLYLOC – THE DIY EASY-FIT, INSTANT ROOF SOLUTION

PolyLoc is an easy-fit roofing panel which provides the ideal DIY roofing solution for verandas, canopies or carports.

The easy-fit panels simply click and lock together to provide an instant roof.

The panels are manufactured from impact-resistant polycarbonate which is hardwearing, durable and long-lasting. The sheeting has added UV protection so that you can enjoy the great outdoors whilst being protected from the harmful effects of the sun.

The panels don't require glazing bars, so they are quick and easy to install, simply clicking and locking into place.

There is 10-year limited warranty against loss of light transmission, yellowing and weather impact available for this product. PolyLoc has a coextruded UV protection layer on one side.



Properties			
Thickness	U-Value (W/m <sup>2</sup> k)	Cover width	Colours
16mm	2.0	500mm	Clear / Opal



## PolyLoc sheeting

Code	Description	Size
PLR202C	PolyLoc System Clear	2000 x 2000 mm
PLR252C	PolyLoc System Clear	2500 x 2000 mm
PLR302C	PolyLoc System Clear	3000 x 2000 mm
PLR352C	PolyLoc System Clear	3500 x 2000 mm
PLR402C	PolyLoc System Clear	4000 x 2000 mm
PLR452C	PolyLoc System Clear	4500 x 2000 mm
PLR502C	PolyLoc System Clear	5000 x 2000 mm
PLR552C	PolyLoc System Clear	5500 x 2000 mm
PLR602C	PolyLoc System Clear	6000 x 2000 mm
PLR202O	PolyLoc System Opal	2000 x 2000 mm
PLR252O	PolyLoc System Opal	2500 x 2000 mm
PLR302O	PolyLoc System Opal	3000 x 2000 mm
PLR352O	PolyLoc System Opal	3500 x 2000 mm
PLR402O	PolyLoc System Opal	4000 x 2000 mm
PLR452O	PolyLoc System Opal	4500 x 2000 mm
PLR502O	PolyLoc System Opal	5000 x 2000 mm
PLR552O	PolyLoc System Opal	5500 x 2000 mm
PLR602O	PolyLoc System Opal	6000 x 2000 mm
PLR203C	PolyLoc System Clear	2000 x 3000 mm
PLR253C	PolyLoc System Clear	2500 x 3000 mm
PLR303C	PolyLoc System Clear	3000 x 3000 mm
PLR353C	PolyLoc System Clear	3500 x 3000 mm
PLR403C	PolyLoc System Clear	4000 x 3000 mm
PLR453C	PolyLoc System Clear	4500 x 3000 mm
PLR503C	PolyLoc System Clear	5000 x 3000 mm
PLR553C	PolyLoc System Clear	5500 x 3000 mm
PLR603C	PolyLoc System Clear	6000 x 3000 mm

## PolyLoc sheeting

Code	Description	Size
PLR203O	PolyLoc System Opal	2000 x 3000 mm
PLR253O	PolyLoc System Opal	2500 x 3000 mm
PLR303O	PolyLoc System Opal	3000 x 3000 mm
PLR353O	PolyLoc System Opal	3500 x 3000 mm
PLR403O	PolyLoc System Opal	4000 x 3000 mm
PLR453O	PolyLoc System Opal	4500 x 3000 mm
PLR503O	PolyLoc System Opal	5000 x 3000 mm
PLR553O	PolyLoc System Opal	5500 x 3000 mm
PLR603O	PolyLoc System Opal	6000 x 3000 mm
PLRC50C	PolyLoc System Clear	2000 x 4000 mm
PLR254C	PolyLoc System Clear	2500 x 4000 mm
PLR304C	PolyLoc System Clear	3000 x 4000 mm
PLR354C	PolyLoc System Clear	3500 x 4000 mm
PLR404C	PolyLoc System Clear	4000 x 4000 mm
PLR454C	PolyLoc System Clear	4500 x 4000 mm
PLR504C	PolyLoc System Clear	5000 x 4000 mm
PLR554C	PolyLoc System Clear	5500 x 4000 mm
PLR604C	PolyLoc System Clear	6000 x 4000 mm
PLR204O	PolyLoc System Opal	2000 x 4000 mm
PLR254O	PolyLoc System Opal	2500 x 4000 mm
PLR304O	PolyLoc System Opal	3000 x 4000 mm
PLR354O	PolyLoc System Opal	3500 x 4000 mm
PLR404O	PolyLoc System Opal	4000 x 4000 mm
PLR454O	PolyLoc System Opal	4500 x 4000 mm
PLR504O	PolyLoc System Opal	5000 x 4000 mm
PLR554O	PolyLoc System Opal	5500 x 4000 mm
PLR604O	PolyLoc System Opal	6000 x 4000 mm

# DISCOVER MORE... OUTDOOR LIVING & GARDEN ROOMS

SEE THE  
FULL RANGE  
IN THE OUTDOOR  
LIVING &  
GARDEN ROOMS  
CATALOGUE

## PRODUCT RANGE



COMPOSITE FENCING



CLADDING



GET YOUR  
COPY FROM  
BRANCH OR  
VIEW A DIGITAL  
VERSION AT  
[EUROCELL.CO.UK](http://EUROCELL.CO.UK)



GARDEN ROOMS

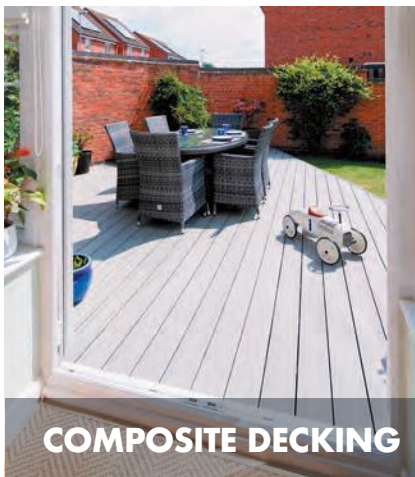

COMPOSITE DECKING

## ALSO...

- DECKING RANGE
- BALUSTRADE SYSTEMS
- ARTIFICIAL DECORATIVE WALL
- GROUND SUPPORT GRID
- RESIN BOUND AGGREGATES
- FIXINGS



TOOLS & SEALANTS



PERGOLAS & VERANDAS



OVER 6000  
PRODUCTS  
IN-BRANCH



210+ BRANCHES  
NATIONWIDE



PRODUCT EXPERTS  
IN EVERY BRANCH



FREE SURVEYS  
& QUOTATIONS



CLICK & COLLECT  
IN-BRANCH



FREE ONSITE  
DELIVERY\*

\*Free onsite delivery on orders over the min. spend - Longer lead times apply to made-to-order items. Applies to mainland UK only and excludes Northern Ireland & Northern Scotland.



# CANOPIES AND PANELS

## CONSERVATORY PVC-U PANELS

DON'T WANT TO BUILD A DWARF WALL, OR GO FOR A FULLY GLAZED CONSERVATORY?

THEN CHOOSE  
PVC-U  
CONSERVATORY  
PANELS INSTEAD

Low-maintenance

Perfectly colour-  
matched to windows  
and roof



## CANOPIES

A VERSATILE RANGE OF STYLISH CANOPIES PROVIDE ADDITIONAL SHELTER

IDEAL FOR:

Residential use

Car ports

Covered walkways

Patio/garden areas

Commercial use

Patio/garden areas





# RAINWATER



## CONTENTS

Rainwater	123
Soil systems	140
Underground	142
Channel Drainage	145



# RAINWATER

High-quality rainwater systems, ideal for small and large scale projects

- Suitable for both domestic and commercial applications, we offer a range of guttering options
- High-capacity gutters and downpipes available, suited for larger commercial buildings
- Available in 6 guttering styles, including decorative cast iron effect

## EUROCELL OFFERS A FULL RANGE OF DRAINAGE SOLUTIONS

### **A** RAINWATER SYSTEMS

Suitable for both domestic and commercial applications, we offer a range of guttering options on page 124

### **B** SOIL DRAINAGE

See the range of components on page 140

### **C** CHANNEL DRAINAGE

Perfect for driveways, patios and plenty more applications. See page 145

### **D** UNDERGROUND DRAINAGE

We offer a 110mm system which can be found on page 142

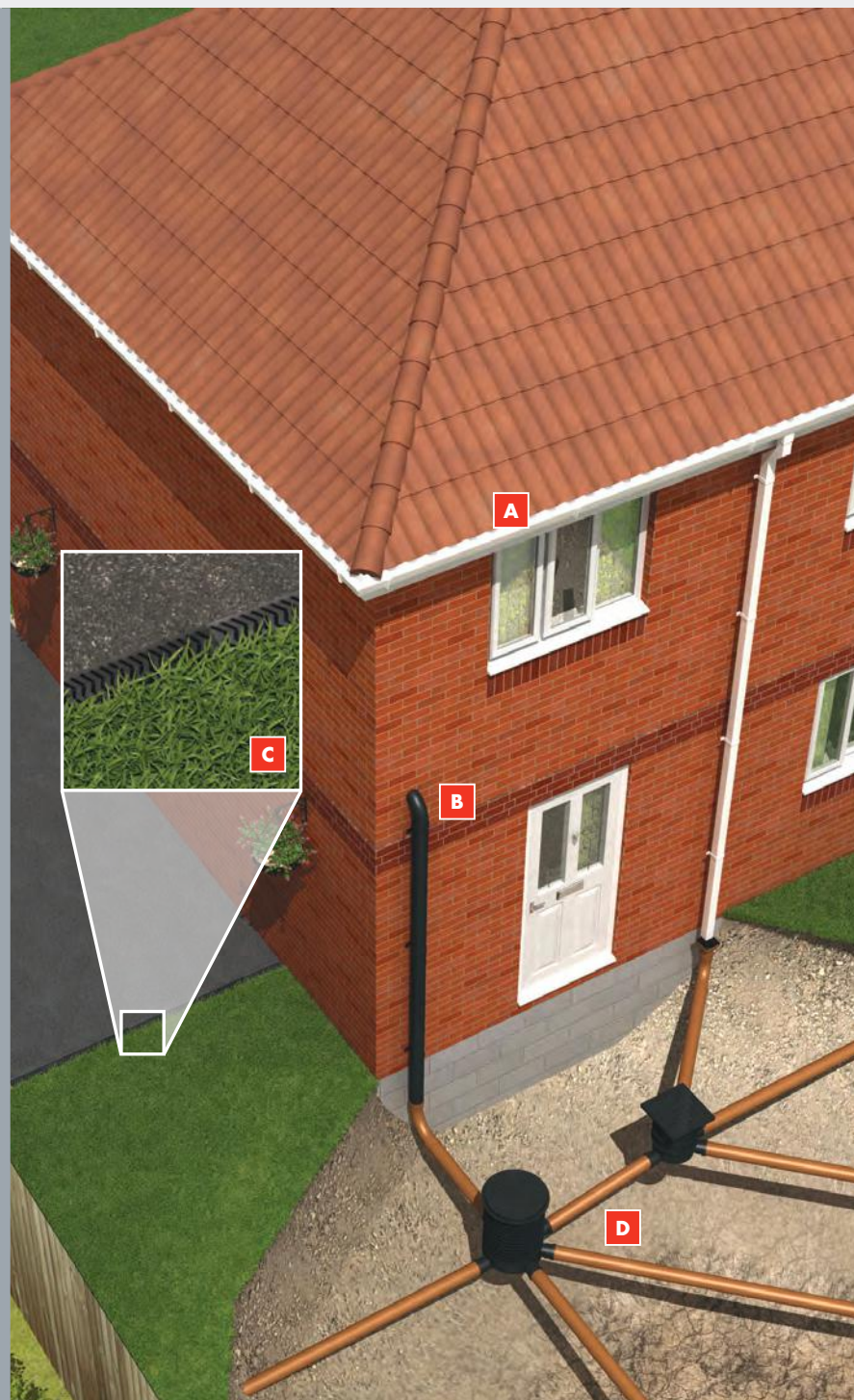

# RAINWATER

## SQUARE-LINE RAINWATER SYSTEM – 114MM

The square-line rainwater system has an easy clip design with rounded ends to ensure simple installation. The system is suited to residential applications, and is compatible with many other existing systems.

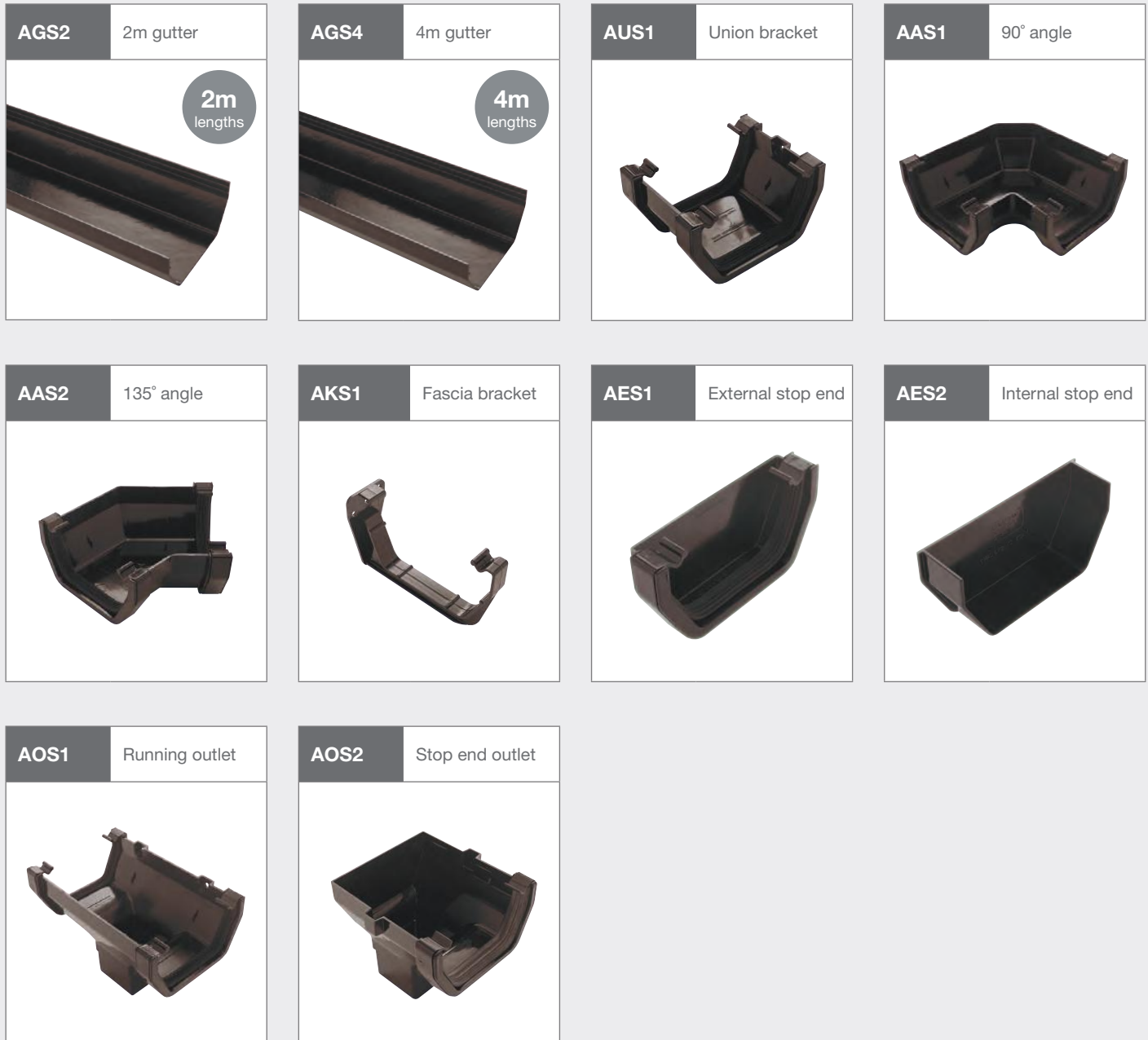



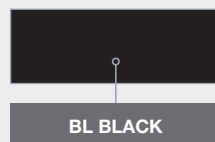
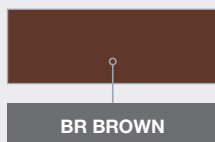
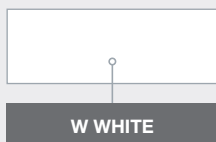







### COLOUR OPTIONS





# HALF-ROUND RAINWATER SYSTEM – 112MM

The half-round rainwater system has an easy-clip design with rounded ends ensuring simple installation. The system is suited to residential applications, and is compatible with many other existing systems.

<p><b>AG2</b> 2m gutter</p> <p>2m lengths</p> 	<p><b>AG4</b> 4m gutter</p> <p>4m lengths</p> 	<p><b>AU1</b> Union bracket</p> 	<p><b>AA1</b> 90° angle</p> 
<p><b>AA2</b> 135° angle</p> 	<p><b>AK1</b> Fascia bracket</p> 	<p><b>AE1</b> External stop end</p> 	<p><b>AE2</b> Internal stop end</p> 
<p><b>AO1</b> Running outlet</p> 	<p><b>AO2</b> Stop end outlet</p> 		

## COLOUR OPTIONS

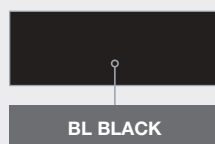
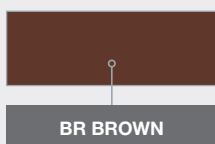

# RAINWATER

## OGEE RAINWATER SYSTEM 135MM

This system is ideal for use on larger residential buildings, smaller commercial premises and conservatory roof applications, as the system is sturdier due to the thick gutter extrusion.

DESIGNED TO AESTHETICALLY  
COMPLEMENT ANY PROPERTY



**AGK04** 4m gutter



**AAK02** External angle 90°



**AAK04** External angle 135°



**AAK01** Internal angle 90°



**AAK03** Internal angle 135°



**AOK01** Running outlet





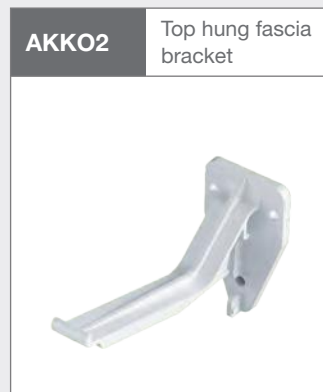





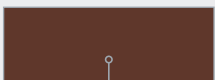

**PERFECT PARTNER**

Klassic Ogee rainwater system perfectly complements our range of decorative OGEE FASCIA BOARDS

**COLOUR OPTIONS**

					
<b>W WHITE</b>		<b>BR BROWN</b>	<b>BL BLACK</b>	<b>AG ANTHRACITE</b>	

# RAINWATER

## DEEP HIGH CAPACITY RAINWATER SYSTEM 120MM

This system is ideal for properties with large roof areas such as terraced / community housing and light commercial buildings.

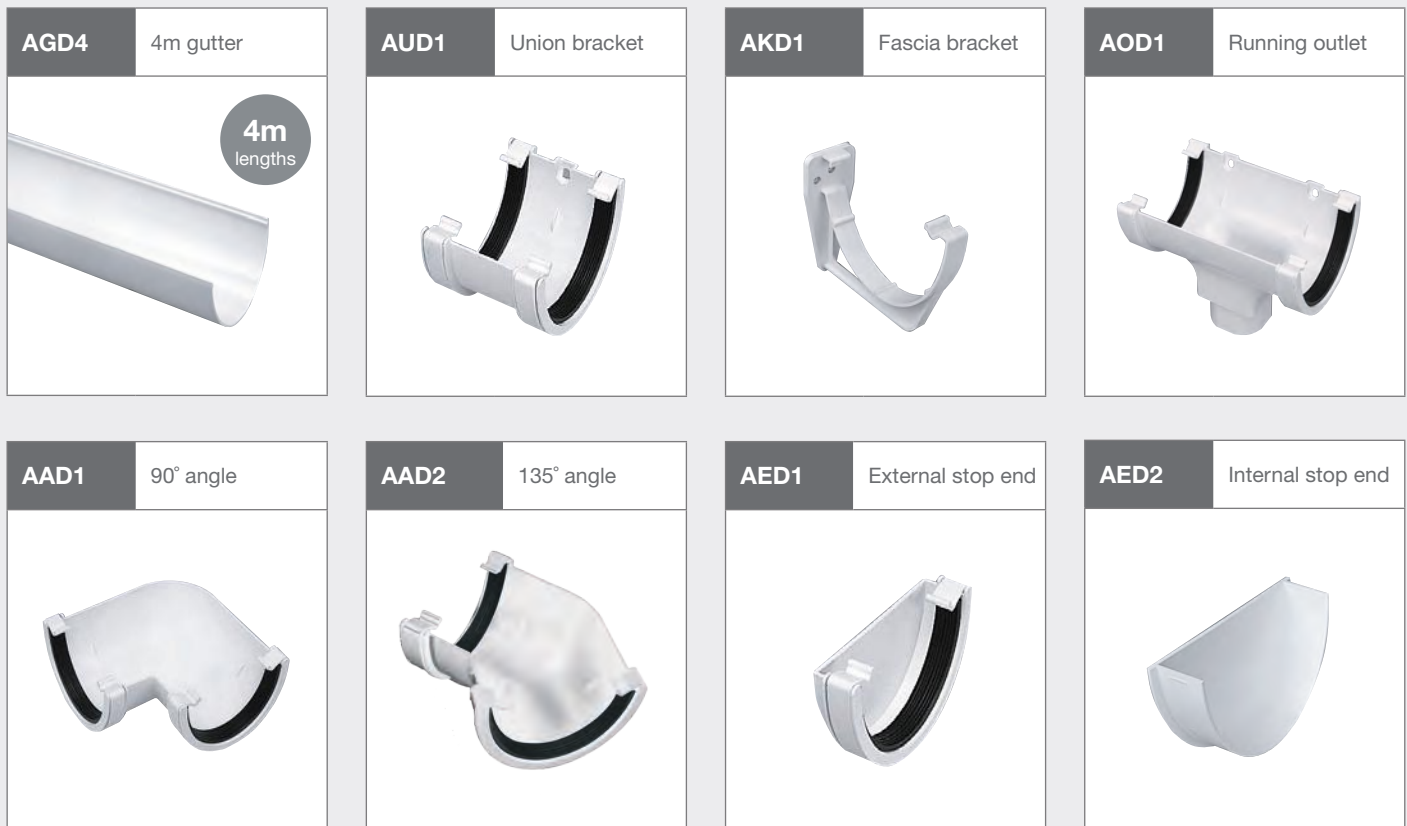



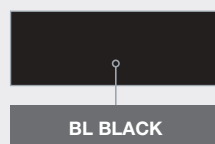





### COLOUR OPTIONS

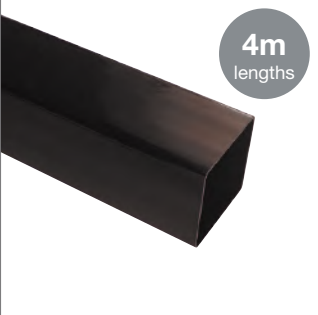



# SQUARE DOWNPIPE RAINWATER SYSTEM

The square line downpipe has an easy to clip design with rounded ends to ensure simple installation. Suitable for Squareline and Ogee.

<p><b>APS25</b> 2.5m pipe</p>  <p>2.5m lengths</p>	<p><b>APS4</b> 4m pipe</p>  <p>4m lengths</p>	<p><b>APS55</b> 5.5m pipe</p>  <p>5.5m lengths</p>	<p><b>ABS1</b> 90° bend</p> 
<p><b>ABS2</b> 112° offset bend</p> 	<p><b>ABS3</b> Shoe</p> 	<p><b>ASS1</b> Pipe socket</p> 	<p><b>AYS1</b> 112° branch</p> 
<p><b>ACS1</b> Pipe clip</p> 	<p><b>ACS2</b> Pipe clip (flush)</p> 	<p><b>PERFECT PARTNER</b></p> <p>Need tools to complete the job? We have spirit levels, hammers, saws and more to help your guttering installation.</p>	

## COLOUR OPTIONS

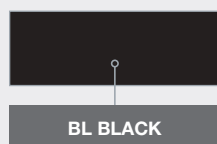

# RAINWATER

## ROUND DOWNPIPE RAINWATER SYSTEM

The round downpipe has an easy to clip design with rounded ends ensuring simple installation. Suitable for Half-Round, Ogee and Deep High Capacity guttering.

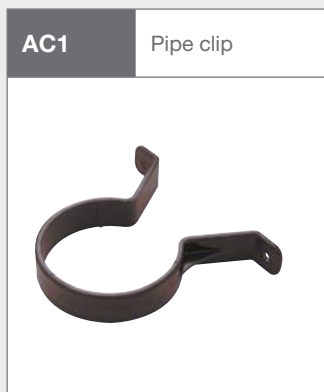
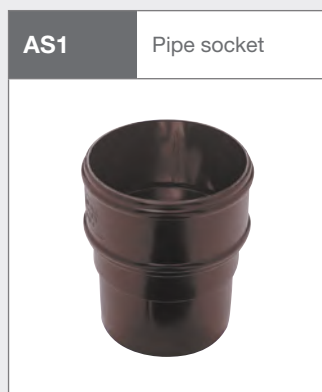

**TRADE DISCOUNTS ARE AVAILABLE**  
- why not open an account in-branch today?

### PERFECT PARTNER

See our full range of fixtures and fitting in-branch.

#### COLOUR OPTIONS

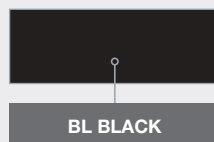
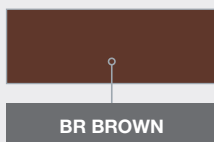
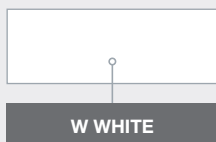



# ADAPTORS

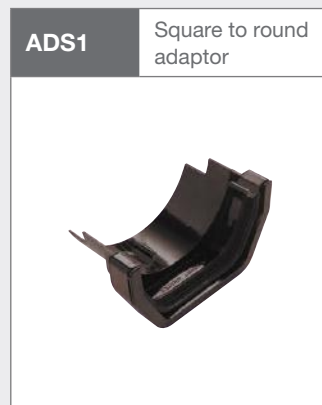
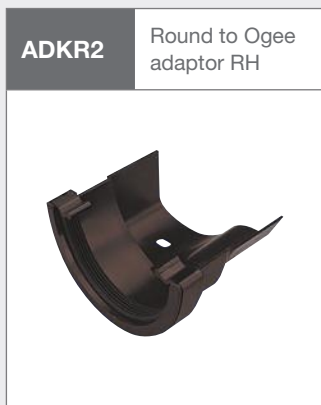

Available in black, brown and white

## GET A TRADE ACCOUNT TODAY

ASK IN BRANCH FOR MORE DETAILS



**OVER 6000  
PRODUCTS AVAILABLE  
IN-BRANCH**



**210+ BRANCHES  
NATIONWIDE**



**INSTANT TRADE CREDIT  
AVAILABLE**



**DEDICATED  
ACCOUNT MANAGER**



**EXCLUSIVE TRADE  
ACCOUNT PRICING**



**ONLINE TRADE  
ACCOUNT**

# RAINWATER

## Brackets & Accessories

The system is suited to residential application and is compatible with many other existing systems.

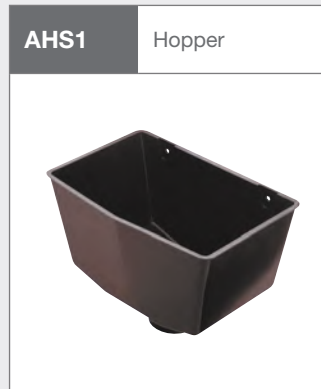
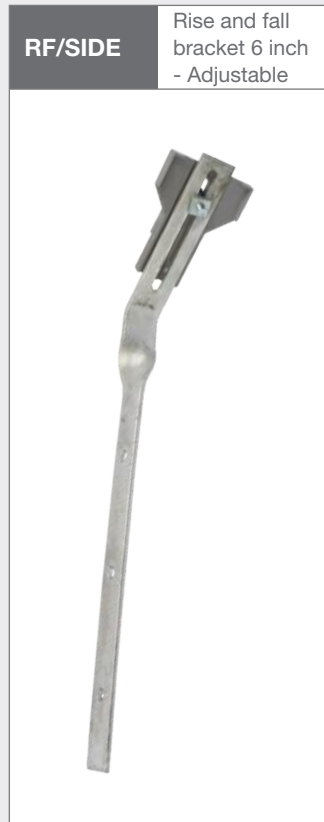

## Gutter brush

FloPlast GutterBrush offers a low maintenance solution for keeping gutters free from debris. Available in black and white.

- Simple to install
- Will flex to fit virtually any shaped gutter system
- Prevents debris such as moss/leaves/twigs/ seeds from blocking the gutter
- Made from high quality Polypropylene filaments securely fixed into a flexible central rust-free stainless steel core
- Low maintenance

### Glazing bars

Code	Description	Unit
<b>GUTTERBRUSHBK</b>	Gutter Brush Black 4m	Each
<b>GUTTERBRUSHWH</b>	Gutter Brush White 4m	Each





# rainwater

PVC-U GUTTERING & DRAINAGE



**UP TO 350 PRODUCTS**

**AVAILABLE IN STOCK NOW**



**UPVC guttering and downpipes with attractive benefits for customers and installers, too.**

When you need effective, hardworking plastic guttering and downpipes that you can fit fast and forget, look no further than the complete range of UPVC rainwater systems and accessories from Eurocell. Our systems are designed to be suitable for all types of domestic and commercial property, from white UPVC guttering to black UPVC guttering

with a wide range of colours in between, and are available in styles from classic half-round and square-line to decorative ogee. We also stock a range of high-capacity gutters and downpipes suitable for larger commercial buildings. Plus, they're quick and easy to fit so you can be sure that your valuable time won't disappear down the drain.



**THE COMPLETE SOLUTION**



**COLOUR MATCH GUARANTEE**



**SEALANTS & FIXINGS IN-STOCK**



**IN 200+ BRANCHES NATIONWIDE**



**INSTANT TRADE CREDIT AVAILABLE**

## COMMERCIAL RAINWATER SYSTEM

150mm

- Designed to handle large volumes of water with ease, as the outlet design encourages a vortex effect for greater water flow down the pipe



# COMMERCIAL RAINWATER SYSTEM (150MM)

Designed to handle large volumes of water with ease, as the outlet design encourages a vortex effect for greater water flow down the pipe. The Commercial system is suited to commercial or large domestic housing projects.

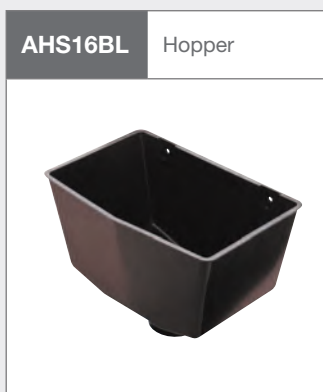
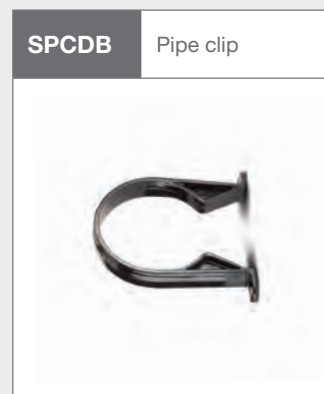
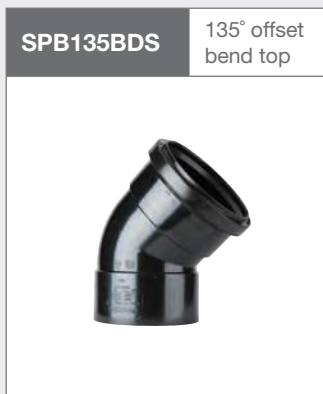
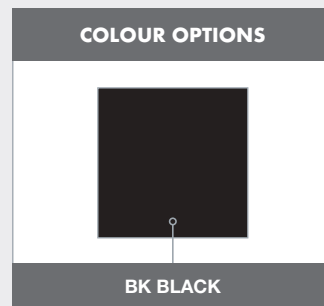





## CAST IRON EFFECT GUTTERING

A stylish range of guttering and downpipe products

### A DECORATIVE EFFECT THAT COMBINES THE LOOK OF A TRADITIONAL CAST IRON SYSTEM

- Quick to install and ready to fit without the need for painting or protective coatings
- Reduced total installation cost. (No metal primer, spanners, paint, or disc cutters required)
- Durable and long-lasting finish without the need to apply corrosion control traditionally used with cast iron systems
- UV stabilised to protect against colour fade
- Lightweight construction for easy handling, assembly and installation
- Stylish and functional, making the range suitable for new build and residential projects



# CAST IRON EFFECT 112MM PVC-U

The Cast Iron Effect System offers a high capacity rainwater solution while still benefiting from the timeless appearance of a Cast Iron Effect rainwater system. Its deep semi-elliptical profile means it can be used on most domestic applications.



## CAST IRON EFFECT RANGE

### HINTS & TIPS

The Elegance range has all of the product & installation benefits of using PVC-U as the manufacturing material

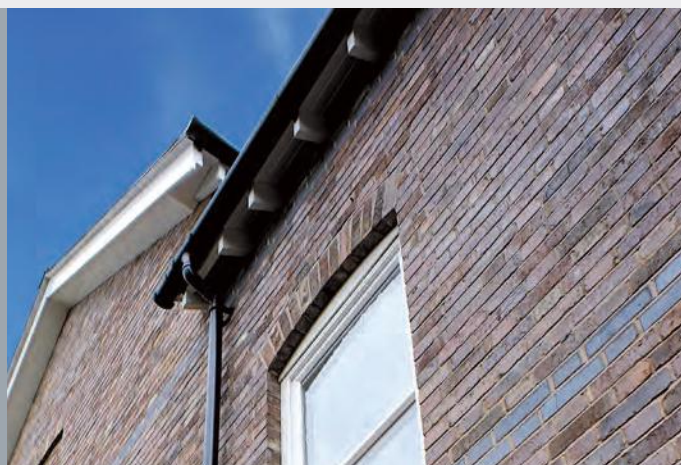

# CAST IRON EFFECT

## CAST IRON EFFECT DOWNPIPE SYSTEMS PVC-U

The Elegance range is designed in such way that each profile system in the range utilises a common downpipe.

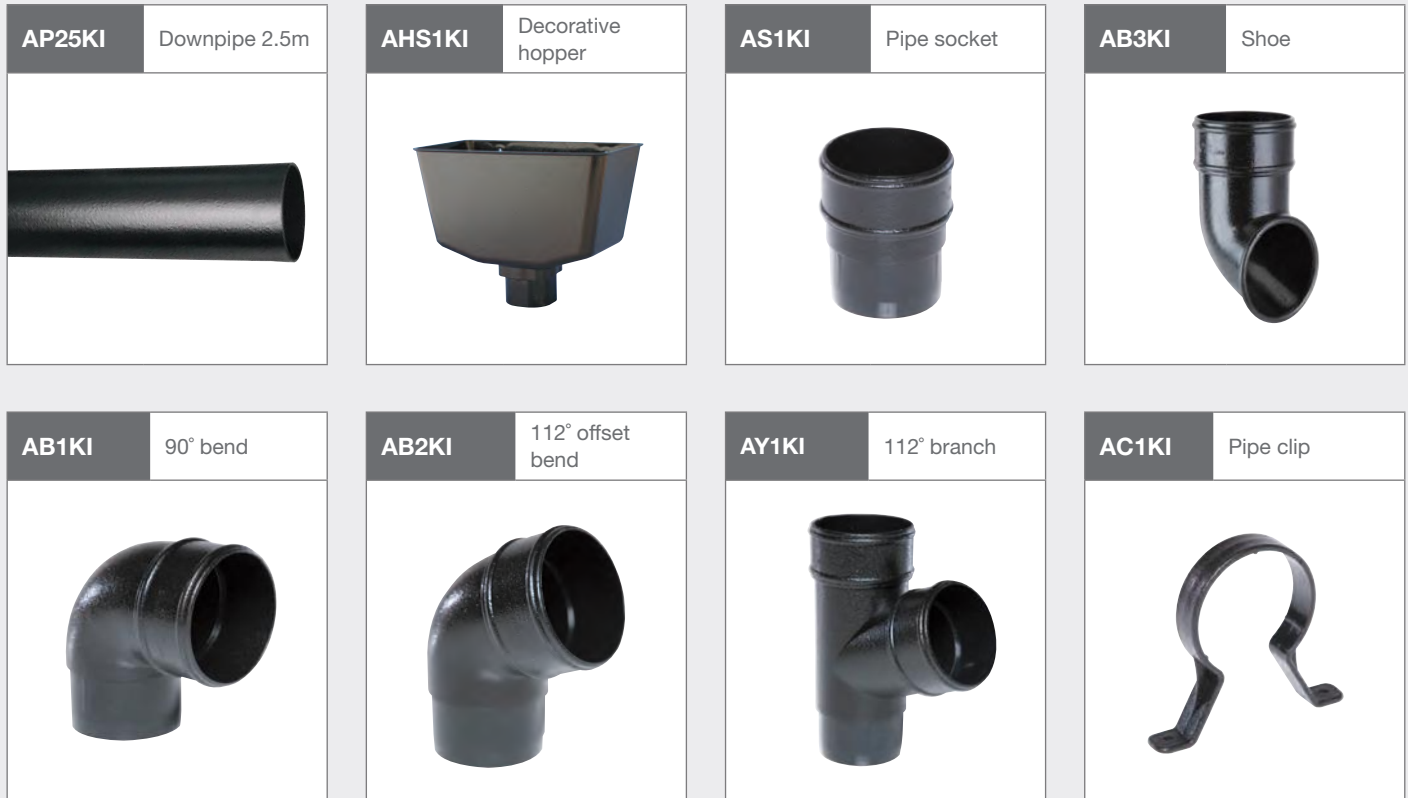

### GET A TRADE ACCOUNT TODAY

ASK IN BRANCH FOR MORE DETAILS

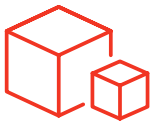

**OVER 6000  
PRODUCTS AVAILABLE  
IN-BRANCH**



**210+ BRANCHES  
NATIONWIDE**



**INSTANT TRADE CREDIT  
AVAILABLE**



**DEDICATED  
ACCOUNT MANAGER**



**EXCLUSIVE TRADE  
ACCOUNT PRICING**



**ONLINE TRADE  
ACCOUNT**



# ACCESS EQUIPMENT

## Roof hook kit

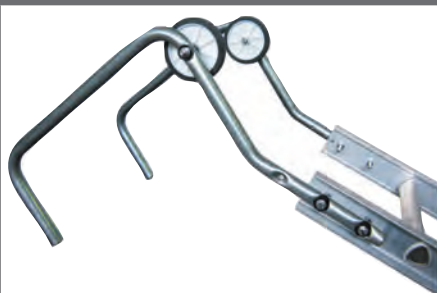

Code

ROOFHOOK

## Hop up aluminium work platform



Code

HOP-UP

Size

825mm

## Roof clamps

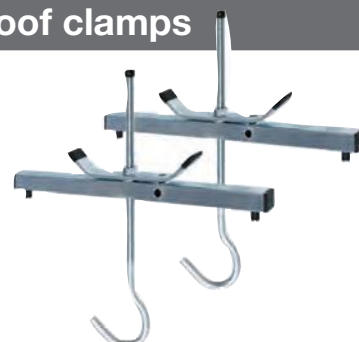

Code

ROOFCLAMPS

## Ladder stay



Code

LADDERSTAY

## Aluminium mobile access tower (not stocked)

Code

TOWER2.6M

Size

2.6m

TOWER3.7M

3.7m

TOWER5.7M

5.7

TOWER7.8M

7.8m



## Click n climb telescopic ladder



Code

TELELADDER

## D rung extension ladder



Code

LADDERSTAY

# SOIL SYSTEMS

## RELIABLE SOIL SOLUTIONS

Maximum durability

Cost-effective

Push-fit style is quick and easy to install

Reliable watertight joints

Interchangeable with leading manufacturer's products made to EN1329

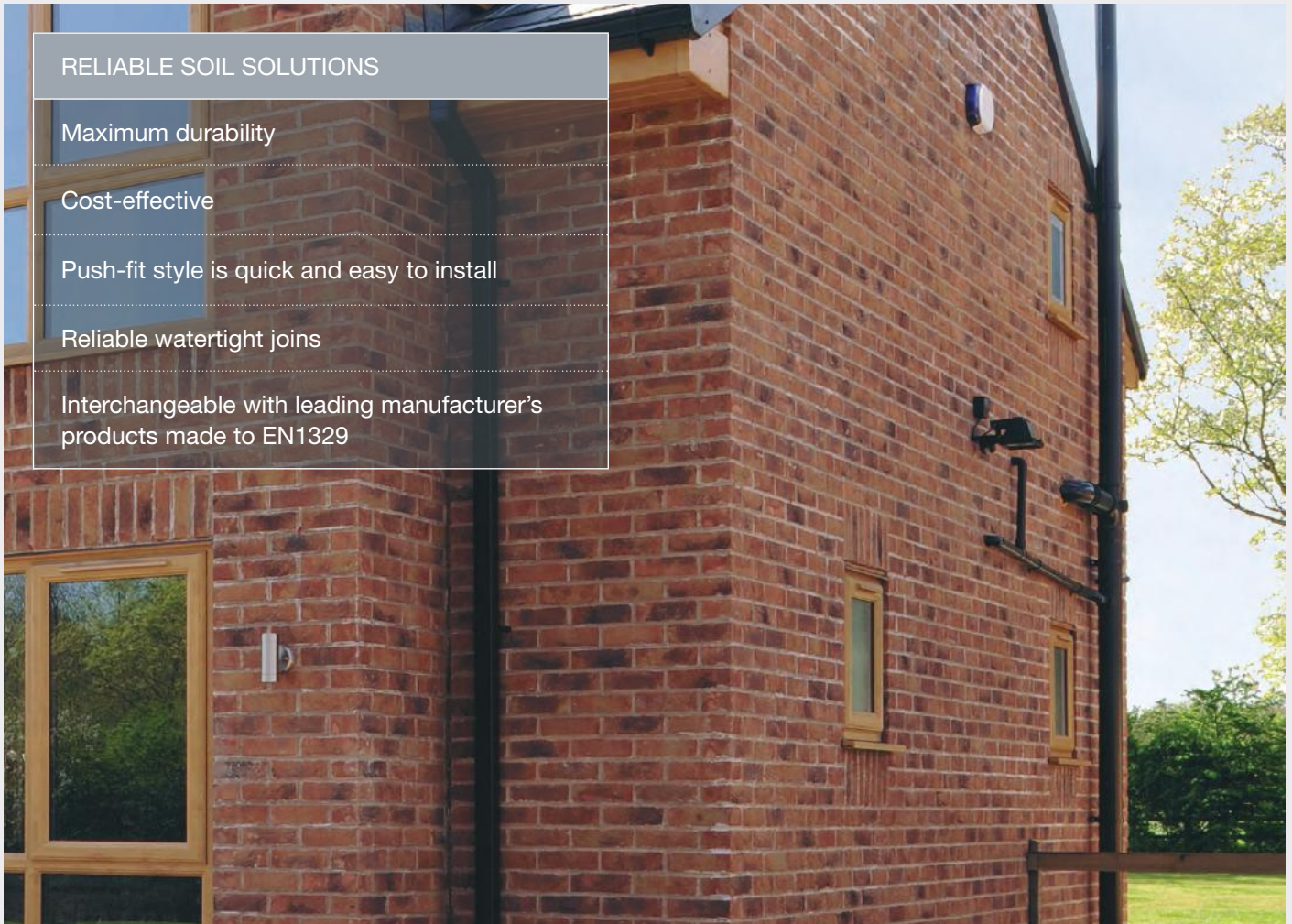

## 110MM SYSTEM

IDEAL FOR DOMESTIC AND COMMERCIAL APPLICATIONS

SPS3

3m soil pipe (single socket)



3m  
length

EDSC

Double socket coupling



SPCD

Pipe clip



SSOB

Strap boss



**EDSBSS135** 45° soil bend (sgl socket)



**EDSBSS92.5** 90° soil bend (sgl socket)



**SAFB** 90° angle access bend (sgl socket)



**EDSBDS92.5** 90° soil bend (dbl socket)



**EDSBR92.5** 90° soil branch (dbl socket)



**SAFT** 90° access branch (dbl socket)



**EDSBR135** 45° soil branch (dbl socket)



**EDSBRT92.5** 90° soil branch (triple socket)



**SSBP** Soil boss pipe



**SVC** Soil vent cage



**SWC** Soil weathering collar



**AV110** Air admittance valve





# UNDERGROUND DRAINAGE



GREAT VALUE, MAINTENANCE-FREE UNDERGROUND DRAINAGE

Easy to lay

Flexible – to accommodate normal ground movement

Adaptable – connects to existing drainage systems

Suitable for commercial and residential installations

Available in 82mm, 110mm, 160mm diameters

## 110MM SYSTEM (160MM SYSTEM AVAILABLE TO ORDER - ASK FOR DETAILS)

**UGP3M** 110mm 3m pipe plain ended

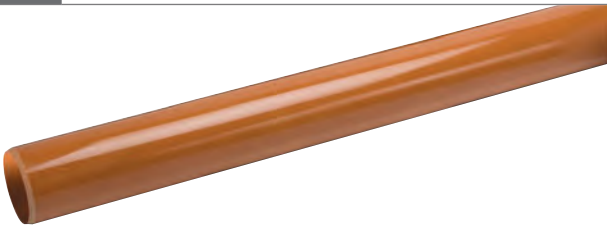

**EDUC** 110mm coupler double socket



**KPSL1000** Soluble Lubricant



**EDUBSS87.5** 110mm 87.5° bend single socket



**EDUBSS45** 110mm 45° bend single socket



**EDUBSS30** 110mm 30° bend single socket







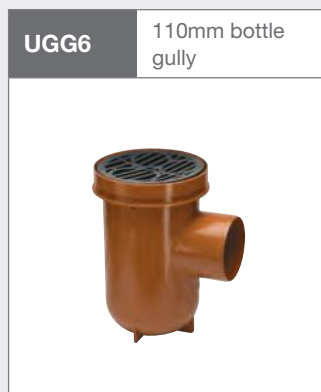





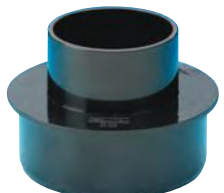

**EDUBSS15** 110mm 15° bend single socket



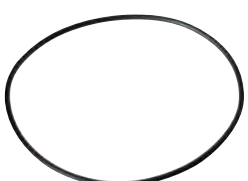
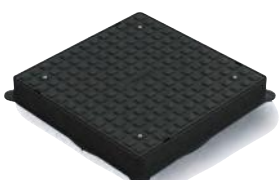

# UNDERGROUND DRAINAGE

<b>UGG3</b>	110mm lowback "P" trap	<b>UGG1</b>	110mm universal gully trap	<b>UGH1</b>	110mm hopper inc square plastic grid	<b>UGH3</b>	110mm rectangular hopper	
								
<b>UGAF6</b>	110mm 45° rodding eye terminal socket	<b>ADS6BL</b>	110mm universal drain adaptor	<b>JCA02</b>	Flexicon universal drain coupler 100- 115mm	<b>UGMBS</b>	320mm chamber base	
								
<b>UGRS</b>	320mm riser for chamber base c/w seal	<b>UGMC1PL</b>	320mm square PP cover & frame	<b>UGMBL</b>	460mm chamber base 110mm outlets	<b>UGRL</b>	460mm riser 215mm	
								
<b>ED470SEAL</b>	460mm seal for riser	<b>MCCRPLSQ</b>	460mm PP cover & 65mm deep frame	<b>MCCRPL</b>				460mm cover & frame A rated
								



# CHANNEL DRAINAGE

A UNIQUE & EASY TO INSTALL SURFACE WATER DRAINAGE SYSTEM

Easy to assemble, handle and install surface drainage system

Effectively removes water from pedestrian areas

Can withstand 5 tonne vehicle weight

Innovative, lightweight and durable design



KCD5T

1m channel drainage

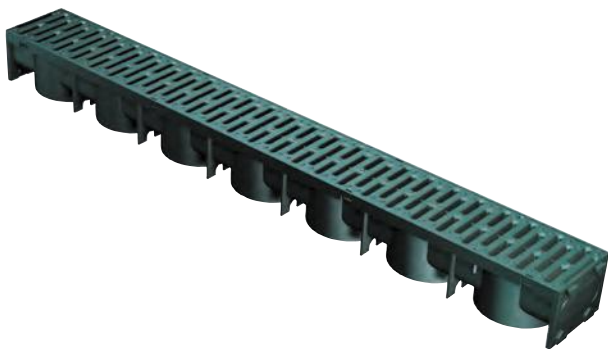

KCD90

Channel drain quad connector  
118 x 118mm



## Hints & tips

### Applications

- Driveways
- Patios
- Garage entrances
- Thresholds





# BUILDING PLASTICS AND A WHOLE LOT MORE. YOUR ONE-STOP SHOP.

**GET A TRADE ACCOUNT TODAY  
AND GET A WHOLE LOT MORE.**

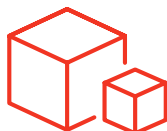

**OVER 6000  
PRODUCTS AVAILABLE  
IN-BRANCH**



**210+ BRANCHES  
NATIONWIDE**



**UP TO £30,000  
CREDIT**



**EXCLUSIVE TRADE  
ACCOUNT PRICING**



**ONLINE TRADE  
ACCOUNT**



**DEDICATED  
ACCOUNT MANAGER**



**SIGN UP TODAY. ASK IN BRANCH TODAY FOR MORE DETAILS.**



**SHOP 24/7  
EUROCELL.CO.UK**



**CLICK & COLLECT  
IN-BRANCH**



**FREE ONSITE  
DELIVERY\***



**BUILDING PLASTICS**

\*Free onsite delivery on orders over the min. spend - Longer lead times apply to made-to-order items. Applies to mainland UK only and excludes Northern Ireland & Northern Scotland.



# ULTRA FLEX<sup>®</sup>

## HIGH PERFORMANCE LIQUID WATERPROOFING SYSTEM

### FEATURES & BENEFITS

**ULTRAFLEX** is a moisture cured , single component liquid waterproofing system that can be used straight out of the tin and does not require additives.

#### IDEAL FOR:

- New roofs
- Repair or refurbishment of existing roofs
- Complex detailing
- Box and valley gutters

#### BENEFITS INCLUDE:

- Excellent adhesion to most surfaces
- No primer required
- BBA certified in excess of 25 years
- Early rain resistance
- Cold weather application
- Easy to apply
- Flame/heat free application
- Highly elastometric
- Reinforced & seamless
- Can be applied all year round



UV  
RESISTANCE



FIRE  
CERTIFIED



ALL  
YEAR



BBA  
CERTIFIED



GUARAN-  
TEES



SAFE  
APPLICATION



[www.ultra-flex.com](http://www.ultra-flex.com)  
[info@ultra-flex.com](mailto:info@ultra-flex.com)





**12°**  
CAN NOW BE FITTED  
AT 12° ROOF PITCH!

Made for each other

also ideal for:



modular homes



outdoor living



self-build



listed & conservation



STONE BLACK | 801

PEWTER GREY | 804

RED ROCK | 809

OLIVE GREEN | 814

PLUM | 706

BRICK RED | 709

CHESTNUT BROWN | 712

COACHMAN MIX | 790

...and don't forget to enquire about our TapcoSlate Classic, purpose-built roofing accessories – they make completing the job so much easier!



## There's no better choice for your conservatory roof than market-leading TapcoSlate Classic!

- Lightweight – as low as 12kg per m<sup>2</sup>
- BRE testing for wind-driven rain found TapoSlate Classic to perform much stronger than all equivalent materials tested
- No breakages – will not crack, split or break if dropped or walked upon
- Authentic slate appearance – combines the beauty of slate with modern technology
- Fully tested to BBA Standards, including fire, wind, driven snow & rain, and water absorption
- 40-year warranty!
- Easy to install with pre-marked nailing and exposure guides, plus horizontal spacers
- Easily cut with a fine-toothed saw or sharp utility blade
- Random Edges and patterns with constant colour throughout each slate
- Wide choice of colours to match existing structures or to add a little more pizzazz to your conservatory



SHOP ONLINE  
[eurocell.co.uk/shop](http://eurocell.co.uk/shop)



CALL US  
08000 77 88 88



IN-BRANCH  
[eurocell.co.uk/branch-finder](http://eurocell.co.uk/branch-finder)

FOLLOW US ONLINE:



## BUILDING PLASTICS AND A WHOLE LOT MORE!

Product specifications are subject to change without notification. Please also note that colours shown are illustrative only, as the printing process does not allow 100% accurate colours to be reproduced.

